

DENON

NETWORK CD RECEIVER

RCD-N7

Owner's Manual

Bedienungsanleitung

Manuel de l'Utilisateur

Manuale delle istruzioni

Manual del usuario

Gebruiksaanwijzing

Bruksanvisning

SAFETY PRECAUTIONS



CAUTION
RISK OF ELECTRIC SHOCK
DO NOT OPEN



CAUTION:
TO REDUCE THE RISK OF ELECTRIC SHOCK, DO NOT REMOVE COVER (OR BACK). NO USER-SERVICEABLE PARTS INSIDE. REFER SERVICING TO QUALIFIED SERVICE PERSONNEL.

The lightning flash with arrowhead symbol, within an equilateral triangle, is intended to alert the user to the presence of uninsulated "dangerous voltage" within the product's enclosure that may be of sufficient magnitude to constitute a risk of electric shock to persons.

The exclamation point within an equilateral triangle is intended to alert the user to the presence of important operating and maintenance (servicing) instructions in the literature accompanying the appliance.

WARNING:
TO REDUCE THE RISK OF FIRE OR ELECTRIC SHOCK, DO NOT EXPOSE THIS APPLIANCE TO RAIN OR MOISTURE.

CLASS 1 LASER PRODUCT LUOKAN 1 LASERLAITE KLASS 1 LASERAPPARAT

"CLASS 1
LASER PRODUCT"

- ADVARSEL:** USYNLIG LASERSTRÅLING VED ÅBNING, NÅR SIKKERHEDSAFBRYDERE ER UDE AF FUNKTION. UNDGÅ UDSAETTELSE FOR STRÅLING.
- VAROITUS!** LAITTEEN KÄYTTÄMINEN MUULLA KUIN TÄSSÄ KÄYTTÖOHJEESSA MAINITULLA TAVALLA SAATTAA ALTISTAA KÄYTTÄJÄN TURVALLISUUSLUOKAN 1 YLITTÄVÄLLE NÄKYMÄMTTÖMÄLLE LASERSÄTEILYLLE.
- WARNING:** OM APPARATEN ANVÄNDS PÅ ANNAT SÄTT ÄN I DENNA BRUKSANVISNING SPECIFICERATS, KAN ANVÄNDAREN UTSÄTTAS FÖR OSYNLIG LASERSTRÅLNING SOM ÖVERSKRIDER GRÄNSEN FÖR LASERKLASS 1.



ATTENZIONE: QUESTO APPARECCHIO E' DOTATO DI DISPOSITIVO OTTICO CON RAGGIO LASER. L'USO IMPROPRIO DELL'APPARECCHIO PUO' CAUSARE PERICOLOSE ESPOSIZIONI A RADIAZIONI!

IMPORTANT SAFETY INSTRUCTIONS

1. Read these instructions.
2. Keep these instructions.
3. Heed all warnings.
4. Follow all instructions.
5. Do not use this apparatus near water.
6. Clean only with dry cloth.
7. Do not block any ventilation openings. Install in accordance with the manufacturer's instructions.
8. Do not install near any heat sources such as radiators, heat registers, stoves, or other apparatus (including amplifiers) that produce heat.
9. Protect the power cord from being walked on or pinched particularly at plugs, convenience receptacles, and the point where they exit from the apparatus.
10. Only use attachments/accessories specified by the manufacturer.
11. Use only with the cart, stand, tripod, bracket, or table specified by the manufacturer, or sold with the apparatus. When a cart is used, use caution when moving the cart/apparatus combination to avoid injury from tip-over.
12. Unplug this apparatus during lightning storms or when unused for long periods of time.
13. Refer all servicing to qualified service personnel. Servicing is required when the apparatus has been damaged in any way, such as power-supply cord or plug is damaged, liquid has been spilled or objects have fallen into the apparatus, the apparatus has been exposed to rain or moisture, does not operate normally, or has been dropped.
14. Batteries shall not be exposed to excessive heat such as sunshine, fire or the like.



CE 0678

R&TTE Directive 1999/5/EC

This product may be operated in the following countries;

AT	BE	CZ	DK	FI
FR	DE	GR	HU	IE
IT	NL	PL	PT	SK
ES	SE	GB	NO	CH

Indoor use only.

CAUTION:

To completely disconnect this product from the mains, disconnect the plug from the wall socket outlet. The mains plug is used to completely interrupt the power supply to the unit and must be within easy access by the user.

VORSICHT:

Um dieses Gerät vollständig von der Stromversorgung abzutrennen, ziehen Sie bitte den Stecker aus der Wandsteckdose. Der Netzstecker wird verwendet, um die Stromversorgung zum Gerät völlig zu unterbrechen; er muss für den Benutzer gut und einfach zu erreichen sein.

PRECAUTION:

Pour déconnecter complètement ce produit du courant secteur, débranchez la prise de la prise murale. La prise secteur est utilisée pour couper complètement l'alimentation de l'appareil et l'utilisateur doit pouvoir y accéder facilement.

ATTENZIONE:

Per scollegare completamente questo prodotto dalla rete di alimentazione elettrica, scollegare la spina dalla relativa presa a muro.

La spina di rete viene utilizzata per interrompere completamente l'alimentazione all'unità e deve essere facilmente accessibile all'utente.

PRECAUCIÓN:

Para desconectar completamente este producto de la alimentación eléctrica, desconecte el enchufe del enchufe de la pared. El enchufe de la alimentación eléctrica se utiliza para interrumpir por completo el suministro de alimentación eléctrica a la unidad y debe de encontrarse en un lugar al que el usuario tenga fácil acceso.

WAARSCHUWING:

Om de voeding van dit product volledig te onderbreken moet de stekker uit het stopcontact worden getrokken. De netstekker wordt gebruikt om de stroomtoevoer naar het toestel volledig te onderbreken en moet voor de gebruiker gemakkelijk bereikbaar zijn.

FÖRSIKTIGHETSMÅTT:

Koppla loss stickproppen från eluttaget för att helt skilja produkten från nätet. Stickproppen används för att helt bryta strömförsörjningen till apparaten, och den måste vara lättillgänglig för användaren.

CAUTION:

USE OF CONTROLS OR ADJUSTMENTS OR PERFORMANCE OF PROCEDURES OTHER THAN THOSE SPECIFIED HEREIN MAY RESULT IN HAZARDOUS RADIATION EXPOSURE. THIS PRODUCT SHOULD NOT BE ADJUSTED OR REPAIRED BY ANYONE EXCEPT PROPERLY QUALIFIED SERVICE PERSONNEL.

□ NOTE ON USE / HINWEISE ZUM GEBRAUCH / OBSERVATIONS RELATIVES A L'UTILISATION / NOTE SULL'USO / NOTAS SOBRE EL USO / ALVORENSTE GEBRUIKEN / OBSERVERA ANGÅENDE ANVÄNDNINGEN

WARNINGS	WARNHINWEISE	AVERTISSEMENTS	AVVERTENZE	ADVERTENCIAS	WAARSCHUWINGEN	VARNINGAR
<ul style="list-style-type: none"> • Avoid high temperatures. Allow for sufficient heat dispersion when installed in a rack. • Handle the power cord carefully. Hold the plug when unplugging the cord. • Keep the unit free from moisture, water, and dust. • Unplug the power cord when not using the unit for long periods of time. • Do not obstruct the ventilation holes. • Do not let foreign objects into the unit. • Do not let insecticides, benzene, and thinner come in contact with the unit. • Never disassemble or modify the unit in any way. • Ventilation should not be impeded by covering the ventilation openings with items, such as newspapers, tablecloths or curtains. • Naked flame sources such as lighted candles should not be placed on the unit. • Observe and follow local regulations regarding battery disposal. • Do not expose the unit to dripping or splashing fluids. • Do not place objects filled with liquids, such as vases, on the unit. • Do not handle the mains cord with wet hands. • When the switch is in the OFF position, the equipment is not completely switched off from MAINS. • The equipment shall be installed near the power supply so that the power supply is easily accessible. 	<ul style="list-style-type: none"> • Vermeiden Sie hohe Temperaturen. Beachten Sie, dass eine ausreichende Belüftung gewährleistet wird, wenn das Gerät auf ein Regal gestellt wird. • Gehen Sie vorsichtig mit dem Netzkabel um. Halten Sie das Kabel am Stecker, wenn Sie den Stecker herausziehen. • Halten Sie das Gerät von Feuchtigkeit, Wasser und Staub fern. • Wenn das Gerät längere Zeit nicht verwendet werden soll, trennen Sie das Netzkabel vom Netzstecker. • Decken Sie den Lüftungsbereich nicht ab. • Lassen Sie keine fremden Gegenstände in das Gerät kommen. • Lassen Sie das Gerät nicht mit Insektiziden, Benzin oder Verdünnungsmitteln in Berührung kommen. • Versuchen Sie niemals das Gerät auseinander zu nehmen oder zu verändern. • Die Belüftung sollte auf keinen Fall durch das Abdecken der Belüftungsöffnungen durch Gegenstände wie beispielsweise Zeitungen, Tischtücher, Vorhänge o. Ä. behindert werden. • Auf dem Gerät sollten keinerlei direkte Feuerquellen wie beispielsweise angezündete Kerzen aufgestellt werden. • Bitte beachten Sie bei der Entsorgung der Batterien die örtlich geltenden Umweltbestimmungen. • Das Gerät sollte keiner tropfenden oder spritzenden Flüssigkeit ausgesetzt werden. • Auf dem Gerät sollten keine mit Flüssigkeit gefüllten Behälter wie beispielsweise Vasen aufgestellt werden. • Das Netzkabel nicht mit feuchten oder nassen Händen anfassen. • Wenn der Schalter ausgeschaltet ist (OFF-Position), ist das Gerät nicht vollständig vom Stromnetz (MAINS) abgetrennt. • Das Gerät sollte in der Nähe einer Netzsteckdose aufgestellt werden, damit es leicht an das Stromnetz angeschlossen werden kann. 	<ul style="list-style-type: none"> • Eviter des températures élevées. • Tenir compte d'une dispersion de chaleur suffisante lors de l'installation sur une étagère. • Manipuler le cordon d'alimentation avec précaution. Tenir la prise lors du débranchement du cordon. • Protéger l'appareil contre l'humidité, l'eau et la poussière. • Débrancher le cordon d'alimentation lorsque l'appareil n'est pas utilisé pendant de longues périodes. • Ne pas obstruer les trous d'aération. • Ne pas laisser des objets étrangers dans l'appareil. • Ne pas mettre en contact des insecticides, du benzène et un diluant avec l'appareil. • Ne jamais démonter ou modifier l'appareil d'une manière ou d'une autre. • Ne pas recouvrir les orifices de ventilation avec des objets tels que des journaux, nappes ou rideaux. Cela entraverait la ventilation. • Ne jamais placer de flamme nue sur l'appareil, notamment des bougies allumées. • Veillez à respecter les lois en vigueur lorsque vous jetez les piles usagées. • L'appareil ne doit pas être exposé à l'eau ou à l'humidité. • Ne pas poser d'objet contenant du liquide, par exemple un vase, sur l'appareil. • Ne pas manipuler le cordon d'alimentation avec les mains mouillées. • Lorsque l'interrupteur est sur la position OFF, l'appareil n'est pas complètement déconnecté du SECTEUR (MAINS). • L'appareil sera installé près de la source d'alimentation, de sorte que cette dernière soit facilement accessible. 	<ul style="list-style-type: none"> • Evitate di esporre l'unità a temperature elevate. • Assicuratevi che vi sia un'adeguata dispersione del calore quando installate l'unità in un mobile per componenti audio. • Maneggiate il cavo di alimentazione con attenzione. Tenete ferma la spina quando scollegate il cavo dalla presa. • Tenete l'unità lontana dall'umidità, dall'acqua e dalla polvere. • Scollegate il cavo di alimentazione quando prevedete di non utilizzare l'unità per un lungo periodo di tempo. • Non coprite i fori di ventilazione. • Non inserite corpi estranei all'interno dell'unità. • Assicuratevi che l'unità non entri in contatto con insetticidi, benzolo o solventi. • Non smontate né modificate l'unità in alcun modo. • Le aperture di ventilazione non devono essere ostruite coprendole con oggetti, quali giornali, tovaglie, tende e così via. • Non posizionate sull'unità fi amme libere, come ad esempio candele accese. • Prestate attenzione agli aspetti legati alla tutela dell'ambiente nello smaltimento delle batterie. • L'apparecchiatura non deve essere esposta a gocciolii o spruzzi. • Non posizionate sull'unità alcun oggetto contenente liquidi, come ad esempio i vasi. • Non toccare il cavo di alimentazione con le mani bagnate. • Quando l'interruttore è nella posizione OFF, l'apparecchiatura non è completamente scollegata da MAINS. • L'apparecchio va installato in prossimità della fonte di alimentazione, in modo che quest'ultima sia facilmente accessibile. 	<ul style="list-style-type: none"> • Evite altas temperaturas. Permita la suficiente dispersión del calor cuando está instalado en la consola. • Maneje el cordón de energía con cuidado. Sostenga el enchufe cuando desconecte el cordón de energía. • Mantenga el equipo libre de humedad, agua y polvo. • Desconecte el cordón de energía cuando no utilice el equipo por mucho tiempo. • No obstruya los orificios de ventilación. • No deje objetos extraños dentro del equipo. • No permita el contacto de insecticidas, gasolina y diluyentes con el equipo. • Nunca desarme o modifique el equipo de ninguna manera. • La ventilación no debe quedar obstruida por haberse cubierto las aperturas con objetos como periódicos, manteles o cortinas. • No deberán colocarse sobre el aparato fuentes inflamables sin protección, como velas encendidas. • A la hora de deshacerse de las pilas, respete la normativa para el cuidado del medio ambiente. • No exponer el aparato al goteo o salpicaduras cuando se utilice. • No colocar sobre el aparato objetos llenos de líquido, como jarras. • No maneje el cable de alimentación con las manos mojadas. • Cuando el interruptor está en la posición OFF, el equipo no está completamente desconectado de la alimentación MAINS. • El equipo se instalará cerca de la fuente de alimentación de manera que resulte fácil acceder a ella. 	<ul style="list-style-type: none"> • Vermijd hoge temperaturen. Zorg er bij installatie in een audiorack voor, dat de door het toestel geproduceerde warmte goed kan worden afgevoerd. • Hanteer het netsnoer voorzichtig. Houd het snoer bij de stekker vast wanneer deze moet worden aan- of losgekoppeld. • Laat geen vochtigheid, water of stof in het apparaat binnendringen. • Neem altijd het netsnoer uit het stopcontact wanneer het apparaat gedurende een lange periode niet wordt gebruikt. • De ventilatieopeningen mogen niet worden geblokkeerd. • Laat geen vreemde voorwerpen in dit apparaat vallen. • Voorkom dat insecticiden, benzene of ververdunner met dit toestel in contact komen. • Dit toestel mag niet gedemonteerd of aangepast worden. • De ventilatie mag niet worden belemmerd door de ventilatieopeningen af te dekken met bijvoorbeeld kranten, een tafelkleed of gordijnen. • Plaats geen open vlammen, bijvoorbeeld een brandende kaars, op het apparaat. • Houd u steeds aan de milieuvoorschriften wanneer u gebruikte batterijen wegdoet. • Stel het apparaat niet bloot aan druppels of spatten. • Plaats geen voorwerpen gevuld met water, bijvoorbeeld een vaas, op het apparaat. • Raak het netsnoer niet met natte handen aan. • Als de schakelaar op OFF staat, is het apparaat niet volledig losgekoppeld van de netspanning (MAINS). • De apparatuur wordt in de buurt van het stopcontact geïnstalleerd, zodat dit altijd gemakkelijk toegankelijk is. 	<ul style="list-style-type: none"> • Undvik höga temperaturer. Se till att det finns möjlighet till god värmeavledning vid montering i ett rack. • Hantera nätkabeln varsamt. Håll i kabeln när den kopplas från el-uttaget. • Utsätt inte apparaten för fukt, vatten och damm. • Koppla loss nätkabeln om apparaten inte kommer att användas i lång tid. • Täpp inte till ventilationsöppningarna. • Se till att främmande föremål inte tränger in i apparaten. • Se till att inte insektsmedel på spraybruk, bensen och thinner kommer i kontakt med apparatens hölje. • Ta inte isär apparaten och försök inte bygga om den. • Ventilationen bör inte förhindras genom att täcka för ventilationsöppningarna med föremål såsom tidningar, bordsdukar eller gardiner. • Placera inte öppen eld, t.ex. tända ljus, på apparaten. • Tänk på miljöaspekterna när du bortskaffar batterier. • Apparaten får inte utsättas för vätska. • Placera inte föremål fyllda med vätska, t.ex. vaser, på apparaten. • Hantera inte nätsladden med våta händer. • Även om strömbrytaren står i det avstängda läget OFF, så är utrustningen inte helt bortkopplad från det elektriska nätet (MAINS). • Utrustningen ska vara installerad nära strömuttaget så att strömförsörjningen är lätt att tillgå.

• DECLARATION OF CONFORMITY

We declare under our sole responsibility that this product, to which this declaration relates, is in conformity with the following standards:
EN60065, EN55013, EN55020, EN61000-3-2, EN61000-3-3, EN300328, EN301489-01, EN301489-17 and EN50385.
Following the provisions of Low Voltage Directive 2006/95/EC and EMC Directive 2004/108/EC, the EC regulation 1275/2008 and its frame work Directive 2009/125/EC for Energy-related Products (ErP).

• ÜBEREINSTIMMUNGSERKLÄRUNG

Wir erklären unter unserer Verantwortung, daß dieses Produkt, auf das sich diese Erklärung bezieht, den folgenden Standards entspricht:

EN60065, EN55013, EN55020, EN61000-3-2, EN61000-3-3, EN300328, EN301489-01, EN301489-17 und EN50385.
Following the provisions of low voltage directive 2006/95/EC and EMC directive 2004/108/EC, the EC regulation 1275/2008 and its frame work directive 2009/125/EC for energy-related products (ErP).

• DECLARATION OF CONFORMITE

Nous déclarons sous notre seule responsabilité que l'appareil, auquel se réfère cette déclaration, est conforme aux standards suivants:

EN60065, EN55013, EN55020, EN61000-3-2, EN61000-3-3, EN300328, EN301489-01, EN301489-17 et EN50385.
Selon la directive 2006/95/EC concernant la basse tension et la directive CEM 2004/108/EC, la réglementation européenne 1275/2008 et la directive 2009/125/EC établissant un cadre de travail applicable aux produits liés à l'énergie (ErP).

• DICHIARAZIONE DI CONFORMITÀ

Dichiaro con piena responsabilità che questo prodotto, al quale la nostra dichiarazione si riferisce, è conforme alle seguenti normative:

EN60065, EN55013, EN55020, EN61000-3-2, EN61000-3-3, EN300328, EN301489-01, EN301489-17 e EN50385.
Facendo seguito alle disposizioni della direttiva sul basso voltaggio 2006/95/EC alla direttiva EMC 2004/108/EC, alla norma EC 1275/2008 e alla relativa legge quadro 2009/125/EC in materia di prodotti alimentati ad energia (ErP).
QUESTO PRODOTTO È CONFORME
AL D.M. 28/08/95 N. 548

• DECLARACIÓN DE CONFORMIDAD

Declaro bajo nuestra exclusiva responsabilidad que este producto al que hace referencia esta declaración, está conforme con los siguientes estándares:

EN60065, EN55013, EN55020, EN61000-3-2, EN61000-3-3, EN300328, EN301489-01, EN301489-17 y EN50385.
De acuerdo con la directiva sobre baja tensión 2006/95/CE y la directiva sobre CEM 2004/108/CE, la normativa CE 1275/2008 y su directiva marco 2009/125/EC para productos relacionados con la energía (ErP).

• EENVORMIGHEIDSVKLAARING

Wij verklaren uitsluitend op onze verantwoordelijkheid dat dit produkt, waarop deze verklaring betrekking heeft, in overeenstemming is met de volgende normen:

EN60065, EN55013, EN55020, EN61000-3-2, EN61000-3-3, EN300328, EN301489-01, EN301489-17 en EN50385.
Volgens de voorziendingen van lage spanningsrichtlijn 2006/95/EC en EMC-richtlijn 2004/108/EC, de EU-richtlijn 1275/2008 en de kaderrichtlijn 2009/125/EC voor energieverbruikende producten (ErP).

• ÖVERENSSTÄMMELSESINTYG

Härmed intygas helt på eget ansvar att denna produkt, vilken detta intyg avser, uppfyller följande standarder:

EN60065, EN55013, EN55020, EN61000-3-2, EN61000-3-3, EN300328, EN301489-01, EN301489-17 och EN50385.
Uppfyller reglerna i lågspänningsdirektivet 2006/95/EC och EMC-direktivet 2004/108/EC, EU-förordningen 1275/2008 och ramverksdirektivet 2009/125/EC för energirelaterade produkter (ErP).

DENON EUROPE
Division of D&M Germany GmbH
An der Kleinbahn 18, Nettetal,
D-41334 Germany

A NOTE ABOUT RECYCLING:

This product's packaging materials are recyclable and can be reused. Please dispose of any materials in accordance with the local recycling regulations.

When discarding the unit, comply with local rules or regulations.

Batteries should never be thrown away or incinerated but disposed of in accordance with the local regulations concerning battery disposal.

This product and the supplied accessories, excluding the batteries, constitute the applicable product according to the WEEE directive.

HINWEIS ZUM RECYCLING:

Das Verpackungsmaterial dieses Produktes ist zum Recyceln geeignet und kann wieder verwendet werden. Bitte entsorgen Sie alle Materialien entsprechend der örtlichen Recycling-Vorschriften.

Beachten Sie bei der Entsorgung des Gerätes die örtlichen Vorschriften und Bestimmungen.

Die Batterien dürfen nicht in den Hausmüll geworfen oder verbrannt werden; bitte entsorgen Sie die Batterien gemäß der örtlichen Vorschriften.

Dieses Produkt und das im Lieferumfang enthaltene Zubehör (mit Ausnahme der Batterien!) entsprechen der WEEE-Direktive.

UNE REMARQUE CONCERNANT LE RECYCLAGE:

Les matériaux d'emballage de ce produit sont recyclables et peuvent être réutilisés.

Veillez disposer des matériaux conformément aux lois sur le recyclage en vigueur.

Lorsque vous mettez cet appareil au rebut, respectez les lois ou réglementations en vigueur.

Les piles ne doivent jamais être jetées ou incinérées, mais mises au rebut conformément aux lois en vigueur sur la mise au rebut des piles.

Ce produit et les accessoires inclus, à l'exception des piles, sont des produits conformes à la directive DEEE.

NOTA RELATIVA AL RICICLAGGIO:

I materiali di imballaggio di questo prodotto sono riutilizzabili e riciclabili. Smaltire i materiali conformemente alle normative locali sul riciclaggio.

Per lo smaltimento dell'unità, osservare le normative o le leggi locali in vigore.

Non gettare le batterie, né incenerirle, ma smaltirle conformemente alla normativa locale sui rifiuti chimici.

Questo prodotto e gli accessori inclusi nell'imballaggio sono applicabili alla direttiva RAEE, ad eccezione delle batterie.

ACERCA DEL RECICLAJE:

Los materiales de embalaje de este producto son reciclables y se pueden volver a utilizar. Disponga de estos materiales siguiendo los reglamentos de reciclaje de su localidad.

Cuando se deshaga de la unidad, cumpla con las reglas o reglamentos locales.

Las pilas nunca deberán tirarse ni incinerarse. Deberá disponer de ellas siguiendo los reglamentos de su localidad relacionados con los desperdicios químicos.

Este producto junto con los accesorios empaquetados es el producto aplicable a la directiva RAEE excepto pilas.

EEN AANTEKENING MET BETREKKING TOT DE RECYCLING:

Het inpakmateriaal van dit product is recycleerbaar en kan opnieuw gebruikt worden. Er wordt verzocht om zich van elk afvalmateriaal te ontdoen volgens de plaatselijke voorschriften.

Volg voor het wegdoen van de speler de voorschriften voor de verwijdering van wit- en bruingoed op.

Batterijen mogen nooit worden weggegooid of verbrand, maar moeten volgens de plaatselijke voorschriften betreffende chemisch afval worden verwijderd.

Op dit product en de meegeleverde accessoires, m.u.v. de batterijen is de richtlijn voor afgedankte elektrische en elektronische apparaten (WEEE) van toepassing.

OBSERVERA ANGÄENDE ÅTERVINNING:

Produktens emballage är återvinningsbart och kan återanvändas. Kassera det enligt lokala återvinningsbestämmelser. När du kasserar enheten ska du göra det i överensstämmelse med lokala regler och bestämmelser.

Batterier får absolut inte kastas i soporna eller brännas. Kassera dem enligt lokala bestämmelser för kemiskt avfall.

Denna apparat och de tillbehör som levereras med den uppfyller gällande WEEE-direktiv, med undantag av batterierna.



Pb

1. IMPORTANT NOTICE: DO NOT MODIFY THIS PRODUCT

This product, when installed as indicated in the instructions contained in this manual, meets R&TTE directive requirements. Modification of the product could result in hazardous Radio and EMC radiation.

2. CAUTION

- Separation distance of at least 20 cm must be maintained between the antenna of this product and all persons.
- This product and its antenna must not be co-located or operating in conjunction with any other antenna or transmitter.

1. WICHTIGER HINWEIS: NEHMEN SIE KEINE VERÄNDERUNGEN AN DIESEM PRODUKT VOR

Wenn dieses Produkt entsprechend dieser Bedienungsanleitung aufgebaut wird, entspricht es den Anforderungen der R&TTE-Richtlinie. Veränderungen am Produkt können zu gefährlicher Funk- und EMV-Strahlung führen.

2. VORSICHT

- Zwischen der Antenne dieses Produkts und Personen muss ein Schutzabstand von 20 cm eingehalten werden.
- Dieses Produkt und seine Antenne dürfen nicht neben anderen Antennen oder Sendern aufgestellt oder zusammen mit ihnen verwendet werden.

1. MISE EN GARDE IMPORTANTE : NE JAMAIS MODIFIER CE PRODUIT

Si toutes les consignes indiquées dans ce mode ont été respectées pendant son installation, ce produit est conforme aux directives R&TTE. Toute modification du produit risquerait alors de générer des radiations radio et EMC dangereuses.

2. ATTENTION

- L'antenne de l'appareil devra être située à une distance de 20 cm au moins des personnes.
- Ce produit ainsi que son antenne ne devront en aucun cas être utilisés à proximité d'une autre antenne ou transmetteur.

1. AVVERTENZA IMPORTANTE: NON MODIFICARE QUESTO PRODOTTO

Se installato come indicato nelle istruzioni del presente manuale, questo prodotto soddisfa i requisiti della direttiva R&TTE. Eventuali modifiche apportate al prodotto potrebbero causare pericolose radiazioni radio ed EMC.

2. ATTENZIONE

- È necessario mantenere una distanza minima di 20 cm tra l'antenna di questo prodotto e le persone.
- Questo prodotto e la relativa antenna non devono essere posizionati in prossimità di altre antenne o trasmettitori e non devono essere utilizzati congiuntamente a questi ultimi.

1. NOTA IMPORTANTE: NO MODIFIQUE ESTE PRODUCTO

Este producto, si es instalado de acuerdo con las instrucciones contenidas en este manual, cumple los requisitos de la directiva R&TTE. La modificación del producto puede producir radiación de Radio y EMC peligrosa.

2. PRECAUCIÓN

- Se debe mantener una separación de al menos 20 cm entre la antena del producto y las personas.
- Este producto y su antena no debe instalarse ni utilizarse conjuntamente con otra antena o transmisor.

1. BELANGRIJKE MEDEDELING: BRENG AAN DIT PRODUCT GEEN AANPASSINGEN AAN

Dit product, indien geïnstalleerd volgens de aanwijzingen in deze gebruiksaanwijzing, voldoet aan de vereisten van de R&TTE-richtlijn. Aanpassing van dit product kan gevaarlijke radio- en EMC-straling tot gevolg hebben.

2. LET OP

- Houd tussen antenne en personen altijd een afstand van tenminste 20 cm aan.
- Dit product en zijn antenne mogen niet in de buurt van een andere antenne of zender worden geplaatst of in combinatie daarmee worden gebruikt.

1. VIKTIGT: APPARATEN FÅR INTE MODIFIERAS

Under förutsättning att apparaten installeras enligt anvisningarna i denna bruksanvisning, uppfyller denna kraven i R&TTE-direktivet. Ev. modifiering av apparaten kan resultera i farlig radio- och elektromagnetisk strålning.

2. FÖRSIKTIGT

- Se till att det finns ett avstånd på minst 20 cm mellan apparatens antenn och personer i omgivningen.
- Apparaten och dess antenn får inte placeras eller användas i närheten av andra antenner eller sändare.

CAUTIONS ON INSTALLATION

VORSICHTSHINWEISE ZUR AUFSTELLUNG

PRÉCAUTIONS D'INSTALLATION

PRECAUZIONI SULL'INSTALLAZIONE

EMPLAZAMIENTO DE LA INSTALACIÓN

VOORZORGSMAATREGELEN BIJ DE INSTALLATIE

FÖRSIKTIGHET VID INSTALLATIONEN

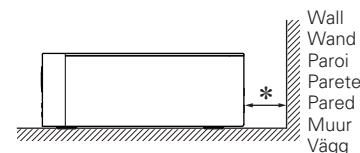
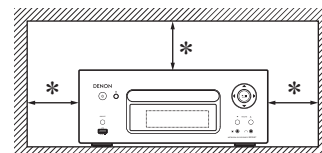

Wall
Wand
Paroi
Parete
Pared
Muur
Vägg

- * **For proper heat dispersal, do not install this unit in a confined space, such as a bookcase or similar enclosure.**
 - More than 0.3 m is recommended.
 - Do not place any other equipment on this unit.
- * **Stellen Sie das Gerät nicht an einem geschlossenen Ort, wie in einem Bücherregal oder einer ähnlichen Einrichtung auf, da dies eine ausreichende Belüftung des Geräts behindern könnte.**
 - Empfohlen wird über 0,3 m.
 - Keine anderen Gegenstände auf das Gerät stellen.
- * **Pour permettre la dissipation de chaleur requise, n'installez pas cette unité dans un espace confiné tel qu'une bibliothèque ou un endroit similaire.**
 - Une distance de plus de 0,3 m est recommandée.
 - Ne placez aucun matériel sur cet appareil.
- * **Per una dispersione adeguata del calore, non installare questa apparecchiatura in uno spazio ristretto, come ad esempio una libreria o simili.**
 - Si raccomanda una distanza superiore ai 0,3 m.
 - Non posizionare alcun altro oggetto o dispositivo su questo dispositivo.
- * **Para la dispersión del calor adecuadamente, no instale este equipo en un lugar confinado tal como una librería o unidad similar.**
 - Se recomienda dejar más de 0,3 m alrededor.
 - No coloque ningún otro equipo sobre la unidad.
- * **Plaats dit toestel niet in een kleine afgesloten ruimte, zoals een boekenkast e.d., omdat anders de warmte niet op gepaste wijze kan worden afgevoerd.**
 - Meer dan 0,3 m is aanbevolen.
 - Plaats geen andere apparatuur op het toestel.
- * **För att tillförsäkra god värmeavledning får utrustningen inte installeras i instängda utrymmen, som t.ex. en bokhylla eller liknande.**
 - Mer än 0,3 m rekommenderas.
 - Placera ingen annan utrustning ovanpå den här enheten.

Contents

Getting started	2
Accessories	2
Main features	2
Cautions on handling	2
About this manual	2
Discs	3
Discs playable on this unit	3
Holding discs	3
Loading discs	3
Cautions on loading discs	3
Cautions on handling	3
Cautions on storing discs	3
Cleaning discs	3
About the remote control	4
Inserting the batteries	4
Operating range of the remote control	4
Connections	5
Speaker connections	5
Connecting the speaker cables	5
Connecting recording components	6
CD recorder / MD recorder	6
Connecting a TV	6
Connecting an antenna	7
FM/AM	7
Connecting to a home network (LAN)	8
Wired LAN	8
Wireless LAN	8
Required system	8
Connecting an iPod	9
iPod Dock	9
USB port	9
Connecting a USB memory device	9
Connecting a portable player	10
Connecting the power cord	10
Basic operations	11
Preparations	11
Turning the power on	11
Turning the power off	11
Setting the current time (Auto Adjust) (24-Hour Display)	11
Operations possible during playback	12
Input source switching	12
Adjusting the master volume	12
Muting the sound	12
Adjusting the tone	12
Setting the sleep timer	13

Switching the display's brightness	13
Listening with headphones	13
CD playback	13
Before playing a disc	13
Playing CDs	13
Switching the display	13
Playing repeatedly (Repeat playback)	14
Playing random order (Random playback)	14
Playing tracks in the desired order (Program playback)	14
MP3 and WMA files playback	15
Playing files	15
Tuner playback	16
Tuning in Broadcast Stations	16
Automatically presetting FM stations (Auto preset)	16
Presetting FM/AM stations manually	17
Listening to preset stations	17
Calling stations registered in Preset List	17
Deleting stations registered in Preset List	17
iPod® playback	17
Before playing an iPod	17
Playing an iPod	17
Disconnecting the iPod	18
USB memory device playback	18
Before playing a USB memory device or an iPod	18
Playing files stored on USB memory devices	18
Network audio playback	19
Listening to internet radio	19
Playing files stored on a music server	20
Listening to Last.fm	21
Listening to Napster	22
Portable audio player playback	23
Playing portable audio player	23
Listening to AUX	23
Favorite function	23
Registering Internet radio stations, music servers and tuners in Favorite List	23
Calling Internet radio stations, files registered or tuners in Favorite List	23
Deleting Internet radio stations, files registered or tuners in Favorite List	23

Advanced operations	24
Tuner playback	24
RDS (Radio Data System)	24
PTY (Program Type)	24
TP (Traffic Program)	25
RT (Radio Text)	25
Menu map	25

Setting the timer [Timer]	26
Setting the everyday timer and once timer	26
Adjusting the clock automatically [Clock]	27
Setting the Time Zone	27
Setting the Summer Time	27
Auto Adjust	27
Setting the current time (Manual Adjust) (24-Hour Display)	27
Setting the network [Network]	28
Connecting Wired LAN	28
Connecting Wireless LAN	29
Last.fm Display	30
Party Mode Function	31
Other Network	32
Setting the others [Other]	33
Auto Standby	33
Screen Saver	33
Using an optimizing filter	33
Firmware Update	33
Other functions	34
Inputting characters	34
Auto power on	35
Last function memory	35
Resetting the microprocessor	35

Information	36
Part names and functions	36
Front panel	36
Top panel	37
Rear panel	37
Remote control	38
MP3 and WMA	41
MP3 and WMA formats	41
iPod®	41
USB memory device	42
Important information	42
Network audio	43
Important information	43

Explanation terms	44
--------------------------------	----

Troubleshooting	45
------------------------------	----

Specifications	49
-----------------------------	----

Index	50
--------------------	----

Getting Started

Connections

Basic Operations

Advanced Operations

Information

Explanation terms

Troubleshooting

Specifications

Index

Getting started

Thank you for purchasing this DENON product. To ensure proper operation, please read these owner's manual carefully before using the product.

After reading them, be sure to keep them for future reference.

Accessories

Check that the following parts are supplied with the product.

① Remote control.....	1
② R03/AAA batteries.....	2
③ AC Power cord (Cord length: Approx. 2 m).....	1
④ AM loop antenna.....	1
⑤ FM indoor antenna.....	1
⑥ Rod antenna for wireless LAN.....	1
⑦ Owner's manual (with Quick setup sheet).....	1
⑧ Service station list.....	1

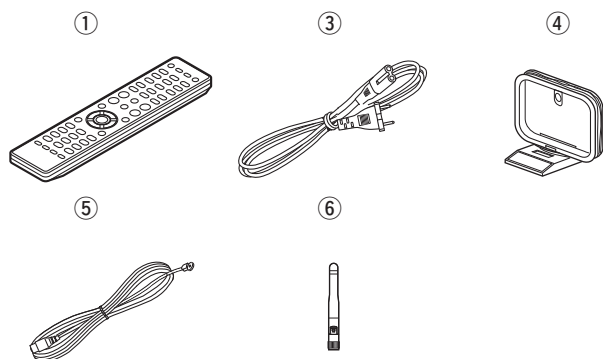

Main features

High quality & high power digital amplifier

DLNA ver. 1.5 supported for Audio Network

Internet radio by vTuner

Equipped with a dock connector that directly connects an iPod or iPhone to this unit

Equipped with Wi-Fi capabilities including Wi-Fi Protected Setup (WPS)

Equipped with a filter for optimizing the response of the speakers (sold separately)

3 Lines OELD (Organic Electroluminescence Display)

Stylish & compact cabinet

Cautions on handling

• Before turning the power switch on

Check once again that all connections are correct and that there are no problems with the connection cables.

• Power is supplied to some of the circuitry even when the unit is set to the standby mode. When going on vacation or leaving home for long periods of time, be sure to unplug the power cord from the power outlet.

• Proper ventilation

If the unit is left in a room full of smoke from cigarettes, etc., for long periods of time, the surface of the optical pickup may get dirty, preventing it from receiving signals properly.

• About condensation

If there is a major difference in temperature between the inside of the unit and its surroundings, condensation may form on parts inside the unit, causing it to fail to operate properly.

If this happens, let the unit sit for an hour or two with the power turned off and wait until there is little difference in temperature before using the unit.

• Cautions on using mobile phones

Using a mobile phone near this unit may result in noise. If that occurs, move the mobile phone away from the unit when it is in use.

• Moving the unit

Turn off the power and unplug the power cord from the power outlet. Next, disconnect the cables connected to other system units before moving the unit.

About this manual

□ Operation buttons

The operations described in this manual are based mainly on remote control operation.

□ Symbols



This symbol indicates a reference page on which related information is described.



This symbol indicates a supplementary information and tips for operations.

NOTE

This symbol indicates points to remember operations or function limitations.

□ Illustrations

Note that the illustrations in these instructions may differ from the actual unit for explanation purposes.

Discs

Discs playable on this unit

1 Music CDs

Discs marked with the logo below can be played in this unit.



2 CD-R/CD-RW

NOTE

- Discs in special shapes (heart-shaped discs, octagonal discs, etc.) cannot be played. Do not attempt to play them, as doing so can damage the unit.
- Some discs and some recording formats cannot be played.
- Non-finalized discs cannot be played.
- What is finalization?
Finalization is the process that makes recorded CD-R/CD-RW discs playable on compatible players.



Holding discs



Do not touch the signal surface.

Loading discs

- Place the disc in the tray, label side up.
- Make sure the disc tray is fully open when inserting the disc.
- Place the discs flat, 12 cm discs in the outer tray guide (Figure 1), 8 cm discs in the inner tray guide (Figure 2).

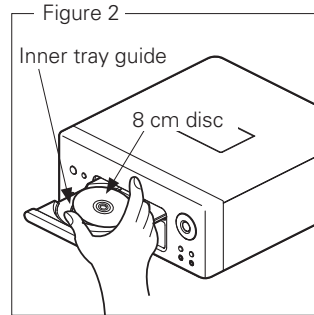
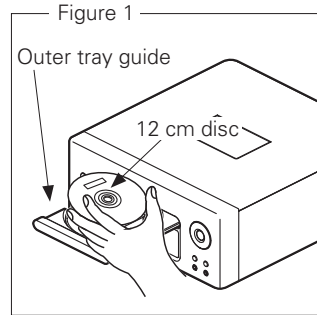

- Place 8 cm discs in the inner tray guide without using an adapter.



- “Unsupported” is displayed if a disc that cannot be played is loaded.
- “No Disc” is displayed if the disc is loaded upside-down or if no disc is loaded.

NOTE

Do not push the disc tray in by hand when the power is turned off. Doing so could damage the set.

Cautions on loading discs

- Only load one disc at a time. Loading two or more discs can damage the unit or scratch the discs.
- Do not use cracked or warped discs or discs that have been repaired with adhesive, etc.
- Do not use discs on which the sticky part of cellophane tape or labels is exposed or on which there are traces of where labels have been removed. Such discs can get caught inside the player and damage it.

Cautions on handling

- Do not get fingerprints, oil or dirt on discs.
- Take special care not to scratch discs when removing them from their cases.
- Do not bend or heat discs.
- Do not enlarge the hole in the center.
- Do not write on the labeled (printed) surface with ball-point pens, pencils, etc., or stick new labels on discs.
- Water droplets may form on discs if they are moved suddenly from a cold place (outdoors for example) to a warm place, but do not try to dry them off using a hairdryer, etc.

Cautions on storing discs

- Be sure to remove discs after using them.
- Be sure to store discs in their cases to protect them from dust, scratches, warping, etc.
- Do not store discs in the following places:
 1. Places exposed to direct sunlight for long periods of time
 2. Dusty or humid places
 3. Places exposed to heat from heaters, etc.

Cleaning discs

- If there are fingerprints or dirt on a disc, wipe them off before using the disc. Fingerprints and dirt can impair sound quality and cause interruptions in playback.
- Use a commercially available disc cleaning set or a soft cloth to clean discs.

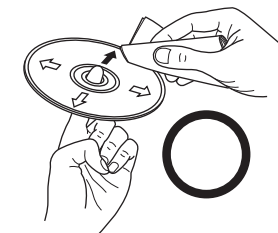

Gently wipe the disc from the inside towards the outside.

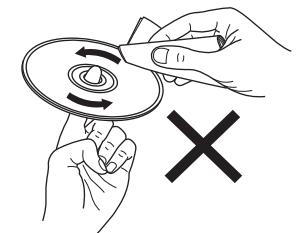

Do not wipe in a circular motion.

NOTE

Do not use record spray, antistatic agents, benzene, thinner or other solvents.

About the remote control

Inserting the batteries

- ① Remove the rear cover of the remote control.
- ② Set two R03/AAA batteries in the battery compartment in the indicated direction.

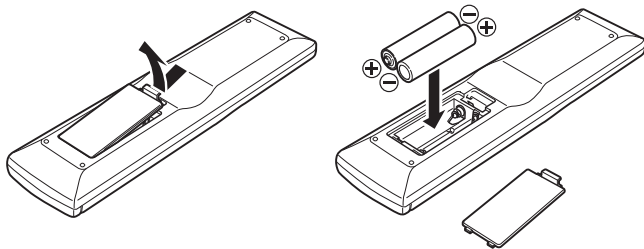

- ③ Put the rear cover back on.

NOTE

- Insert the specified batteries in the remote control unit.
- Replace the batteries with new ones if the set does not operate even when the remote control unit is operated close to the unit. (The supplied batteries are only for verifying operation.)
- When inserting the batteries, be sure to do so in the proper direction, following the ⊕ and ⊖ marks in the battery compartment.
- To prevent damage or leakage of battery fluid:
 - Do not use a new battery together with an old one.
 - Do not use two different types of batteries.
 - Do not attempt to charge dry batteries.
 - Do not short-circuit, disassemble, heat or dispose of batteries in flames.
 - Do not keep the battery in a place exposed to direct sunlight or in places with extremely high temperatures, such as near a heater.
- If the battery fluid should leak, carefully wipe the fluid off the inside of the battery compartment and insert new batteries.
- Remove the batteries from the remote control unit if it will not be in use for long periods.
- Used batteries should be disposed of in accordance with the local regulations regarding battery disposal.

Operating range of the remote control

Operate the remote control while pointing it at the remote sensor.

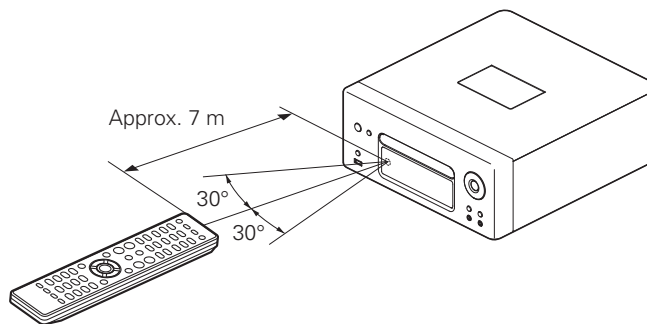

NOTE

The set may function improperly or the remote control may not operate if the remote control sensor is exposed in direct sunlight or strong artificial light such as a fluorescent or infrared light.

Connections

This section explains how to connect speakers, recording equipment, antennas and network. For other connections, see the sections below.

NOTE

- Do not plug in the power cord until all connections have been completed.
- When making connections, also refer to the owner's manual of the other components.
- Be sure to connect the left and right channels properly (left with left, right with right).
- Do not bundle power supply cords together with connection cables. Doing so can result in humming or noise.

Speaker connections

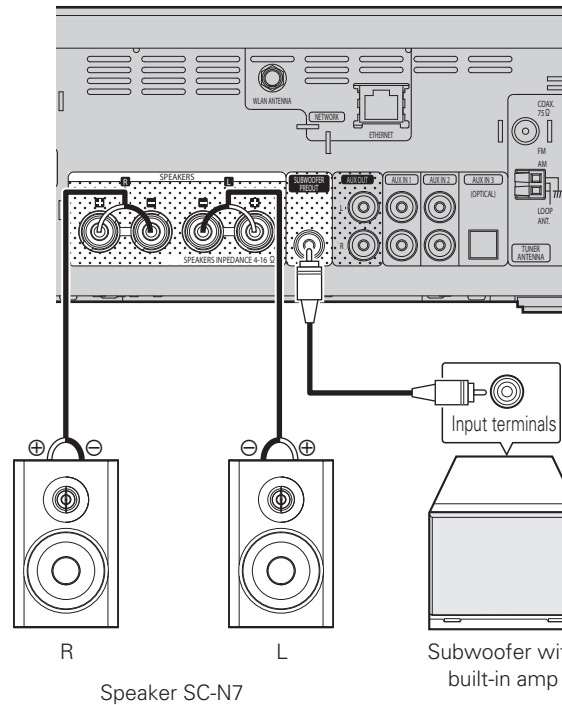
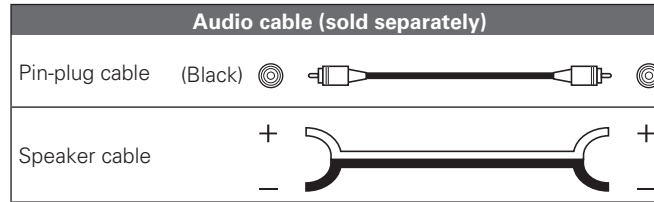

NOTE

Be sure to lower the audio volume before making speaker settings.

Connecting the speaker cables

Carefully check the left (L) and right (R) channels and + (red) and - (black) polarities on the speakers being connected to the unit, and be sure to connect the channels and polarities correctly.

- 1 Peel off about 10 mm of sheathing from the tip of the speaker cable, then either twist the core wire tightly or apply solder to it.**
- 2 Turn the speaker terminal counterclockwise to loosen it.**
- 3 Insert the speaker cable's core wire to all the way into the speaker terminal.**
- 4 Turn the speaker terminal clockwise to tighten it.**

NOTE

- Use speakers with an impedance of 4 to 16 Ω. The protection circuit may be activated if speakers with an impedance other than specified are used.
- Connect the speaker cables so they do not stick out of the speaker terminals. The protection circuit may be activated if the wires touch the rear panel or if the + and - sides touch each other (page 6 "Protection circuit").
- Never touch the speaker terminals while the power supply is connected. Doing so could result in electric shock.
- When you connect optional speakers (SC-N7) to this unit, you can perform the filter setting for optimal sound quality output (page 33 "Using an optimizing filter").

Speaker connections

Protection circuit

The protection circuit is activated in the following situations:

- If the speaker cable wire touches the rear panel or screws or if the speaker cable wire touches the speaker cable's + and - sides are touching
- If the surrounding temperature is extremely high
- If the inside of the amplifier gets hot to extended use at a high output

If this happens, unplug the power cord, then check the connections of the speaker cables and input cables. If the unit becomes very hot, wait for it to cool off and improve the ventilation around it. After doing this, plug the power cord back in.

If the protection circuit is activated even though there are no problems with the ventilation around the unit or in connections, the unit may be damaged. Turn off the power and then contact a DENON service center.

Connecting recording components

CD recorder / MD recorder

Cables used for connections

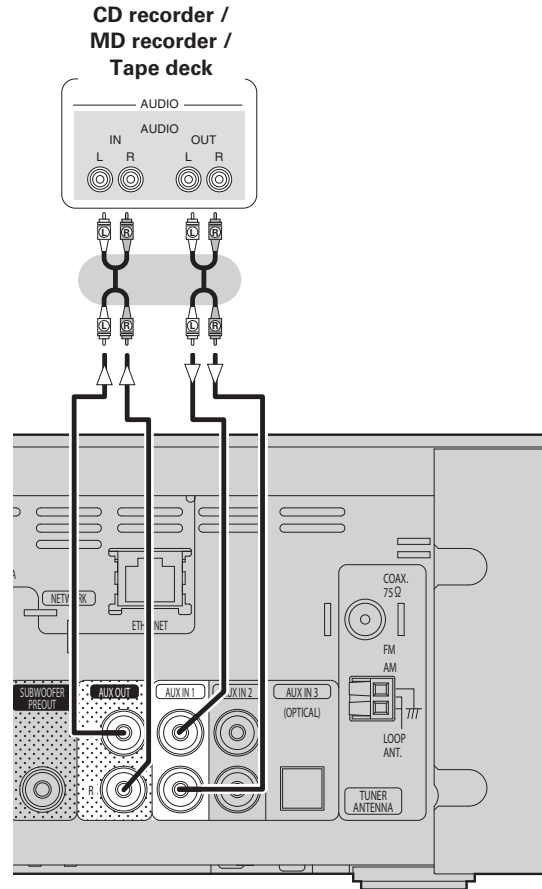
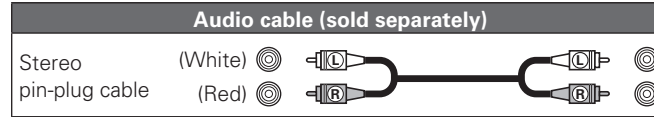

Connecting a TV

- Select the connector to use and connect the device.
- To listen to TV audio through this device, use the optical digital connection.

Cables used for connections

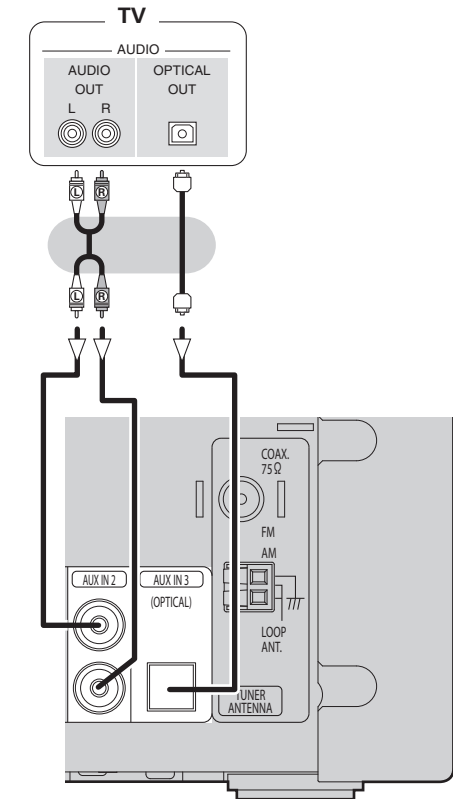
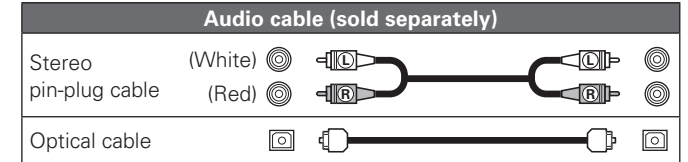

NOTE

Other digital audio signals than 2 channel linear PCM cannot be input through AUX IN 3 (OPTICAL) terminal of this unit. When you try to input digital audio signals other than 2 channel linear PCM to this unit, set the digital audio output setting of the TV to 2 channel PCM. For details, see the operating instructions of the TV.

Connecting an antenna

FM/AM

- Connect the FM antenna or AM loop antenna supplied with the unit to enjoy listening to radio broadcasts.
- After connecting the antenna and receiving a broadcast signal (see page 16 "Tuning in Broadcast Stations"), fix the antenna with tape in a position where the noise level becomes minimal.

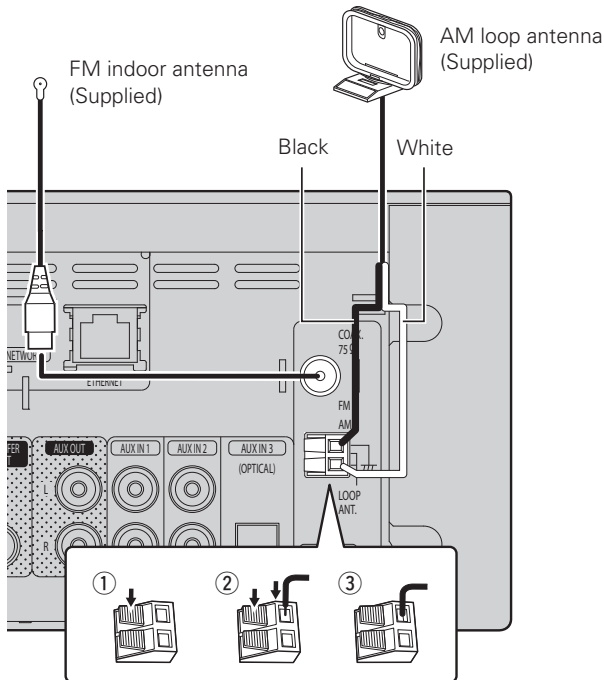

NOTE

- Do not connect two FM antennas simultaneously.
- Even if an external AM antenna is used, do not disconnect the AM loop antenna.
- Make sure the AM loop antenna lead terminals do not touch metal parts of the panel.
- If the signal has noise interference, connect the ground terminal (GND) to reduce noise.
- If you are unable to receive a good broadcast signal, we recommend installing an outdoor antenna. For details, inquire at the retail store where you purchased the unit.

AM loop antenna assembly

1 Put the stand section through the bottom of the loop antenna from the rear and bend it forward.

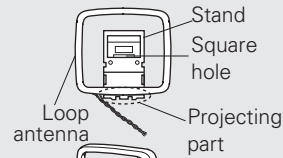

2 Insert the projecting part into the square hole in the stand.

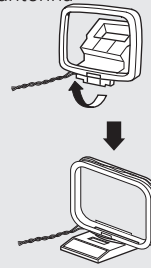

Using the AM loop antenna

Suspending on a wall

Suspend directly on a wall without assembling.

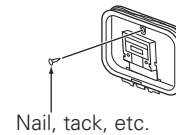

Standing alone

Use the procedure shown upper to assemble.

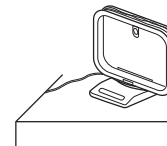

Connecting to a home network (LAN)

- This unit lets you play via your home network (LAN) music files stored on a computer and music content such as that from Internet radio.
- You can update by downloading the latest firmware from the DENON website.
- See "Setting the network [Network]" (page 28) on the menu for more information on network setting.

Wired LAN

Cables used for connections

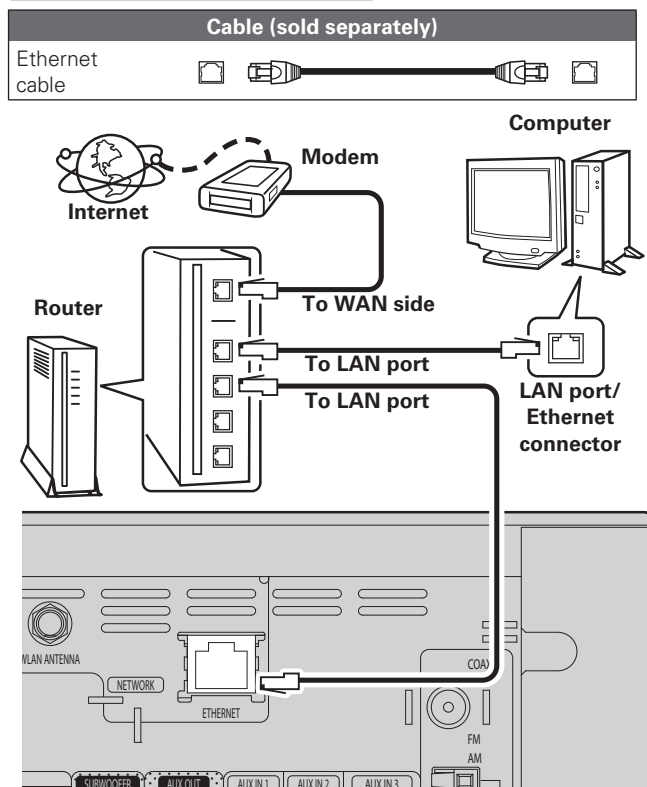

For connections to the Internet, contact an ISP (Internet Service Provider) or a computer shop.

Wireless LAN

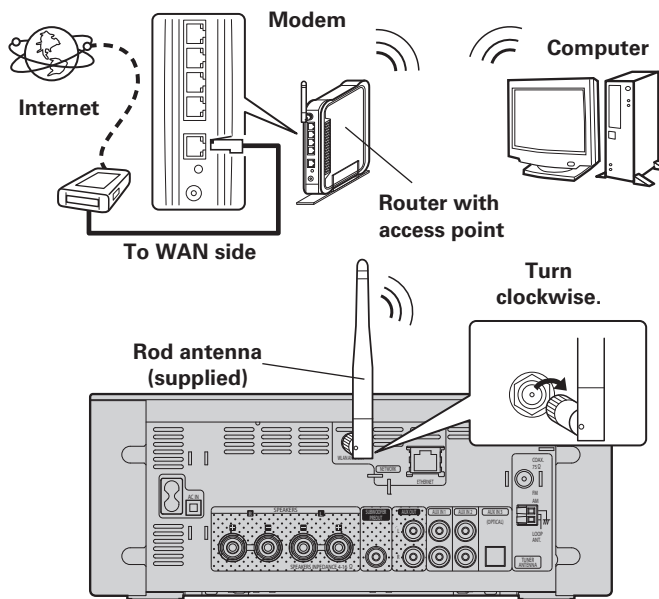

Required system

Broadband internet connection

Modem

Device that connects to the broadband circuit and conducts communications on the Internet.

A type that is integrated with a router is also available.

Router

When using this unit, we recommend you use a router equipped with the following functions:

- Built-in DHCP server
This function automatically assigns IP addresses on the LAN.
- Built-in 100BASE-TX switch
When connecting multiple devices, we recommend a switching hub with a speed of 100 Mbps or greater.
- When using with a wireless LAN, prepare a broadband router with built-in access point.

Ethernet cable (CAT-5 or greater recommended)

- Use only shielded STP or ScTP LAN cable which is available at retailer.
- Some flat type Ethernet cables are easily affected by noise. We recommend using a normal type cable.



- If you have an Internet provider contract for a line on which network settings are made manually, make the settings at "Network connecting (DHCP=Off)" (page 28).
- With this unit, it is possible to use the DHCP and Auto IP functions to make the network settings automatically.
- When using this unit with the broadband router's DHCP function enabled, this unit automatically performs the IP address setting and other settings. When using this unit connected to a network with no DHCP function, make the settings for the IP address, etc., at "Network connecting (DHCP=Off)" (page 28).
- When setting manually, check the setting contents with the network administrator.

NOTE

- A contract with an ISP is required to connect to the Internet. No additional contract is needed if you already have a broadband connection to the Internet.
- The types of routers that can be used depend on the ISP. Contact an ISP or a computer shop for details.
- DENON assumes no responsibility whatsoever for any communication errors or troubles resulting from customer's network environment or connected devices.
- This unit is not compatible with PPPoE. A PPPoE-compatible router is required if you have a contract for a type of line set by PPPoE.
- Do not connect an ETHERNET connector directly to the LAN port/Ethernet connector on your computer.

Connecting an iPod

iPod Dock

Open the lid and mount the adapter suited for your iPod onto the dock adapter included with your iPod.

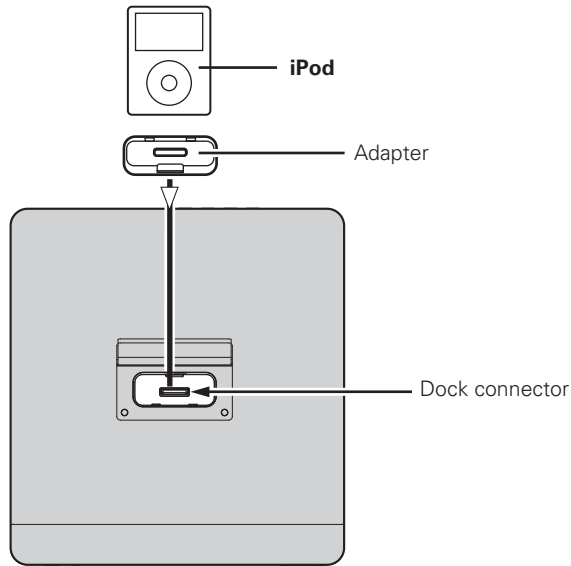

NOTE

- Please make sure to fit adaptor to connector part for use with your iPod.
- When plugging in or unplugging the iPod, please proceed carefully, adjusting the inclination of the connector so as not to place a burden upon the connector.

Loading

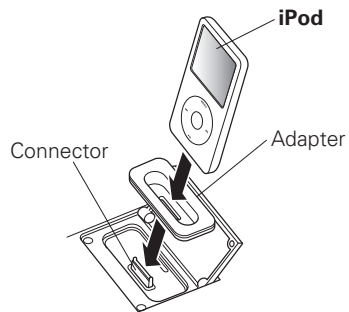

Dismantling

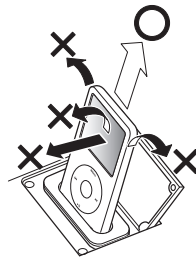

- Keep the dock for iPod's lid closed when your iPod is not connected to prevent any foreign objects from getting inside.
- You can use this unit to perform playback via an iPod (5th generation or later), iPhone (3GS or earlier), iPod touch, iPod classic, or iPod nano. For details, check the Web ([www.denson.com](http://www.denon.com)).

USB port

Cables used for connections

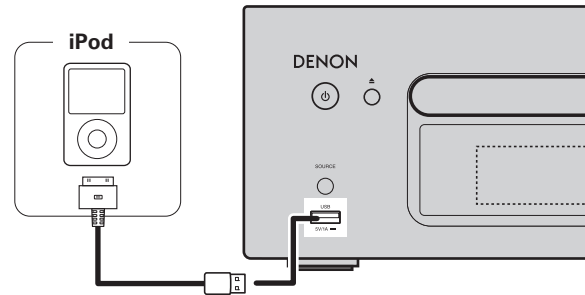
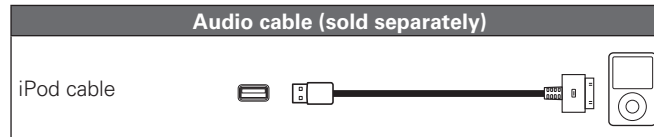

To connect an iPod to this unit, use the iPod cable supplied with the iPod.

Connecting a USB memory device

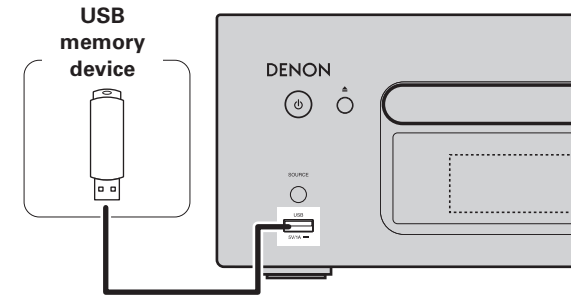

NOTE

- A computer can not be connected to and operate the unit via its USB port.
- Do not use an extension cable when connecting a USB memory device.
- For details about USB memory devices, see "USB memory device" (👉 page 42).

Connecting a portable player

Cables used for connections

Audio cable (sold separately)

Stereo
mini-plug
cable

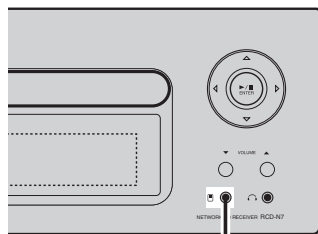

Connect this unit and portable audio player using a separately sold mini-stereo audio cable.

NOTE

After you connect a portable audio player, the input source automatically switches to "Portable In".

Connecting the power cord

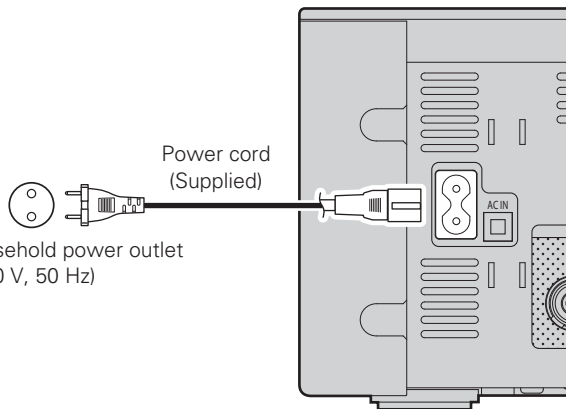

Power cord
(Supplied)

To household power outlet
(AC 230 V, 50 Hz)

NOTE

- Only use the supplied power cord.
- Be sure the power cord is unplugged from the power outlet before connecting or disconnecting it to the AC IN.

Basic operations

Symbols used to indicate buttons in this manual

- Button located on both the main unit and the remote control → **BUTTON**
- Button only on the main unit → **<BUTTON>**
- Button only on the remote control → **[BUTTON]**



ON/STANDBY

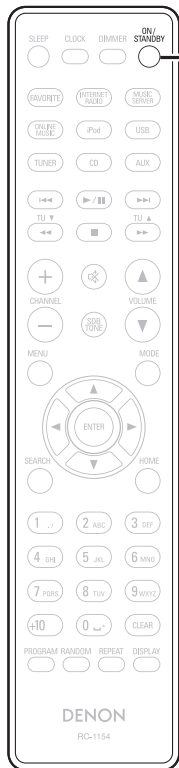

ON/STANDBY

This section provides information on basic operations such as settings and playback procedures. For other operations, see the sections below.

- RDS (Radio Data System) (👉 page 24)
- Setting the timer [Timer] (👉 page 26)
- Setting the others [Other] (👉 page 33)

Preparations

Turning the power on

Press **ON/STANDBY**.

- The power turns on. Press again to set the power to standby.
- Power indicator
 - StandbyOff
 - Power on.....Green
 - When the timer is setOrange

NOTE

- When you turn on the power of this unit for the first time after purchasing it, the Network First Setup menu starts up.
- If you cancelled "Network First Setup" or changed the network environment, perform "Menu" – "Network" – "Network First Setup".
- Power continues to be supplied to some of the circuitry even when the power is in the standby mode. When leaving home for long periods of time, either press **ON/STANDBY** to turn off the power, or unplug the power cord from the power outlet.
- Be sure to stop playback before turning the power off.

Completely turning off the power

- Unplug the power cord from the wall outlet.
- Note that the time setting is cleared when the power cord is unplugged from the outlet.
- The settings made for the various functions may be cleared if the power cord is left unplugged from a power outlet for an extended period of time.

Turning the power off

Press **ON/STANDBY**.

The power indicator turns off, and so does the power.

NOTE

Be sure to stop playback before turning the power off.

Setting the current time (Auto Adjust) (24-Hour Display)

- When the unit is connected to the Internet, the current time is set automatically.
- The default Time Zone setting of this unit is the Central European Time zone. To change the Time Zone and Summer Time, see "Adjusting the clock automatically [Clock]" (👉 page 27).
- When the unit is not connected to the Internet, set the current time manually. See "Setting the current time (Manual Adjust) (24-Hour Display)" (👉 page 27).

Symbols used to indicate buttons in this manual

- Button located on both the main unit and the remote control → **BUTTON**
- Button only on the main unit → **<BUTTON>**
- Button only on the remote control → **[BUTTON]**

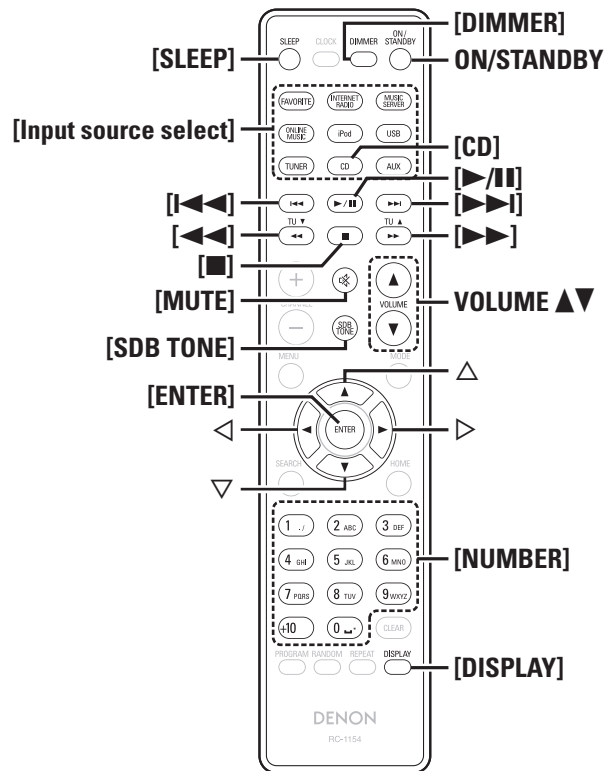
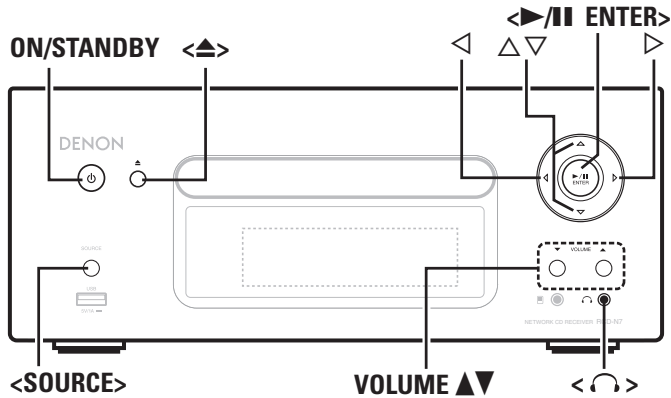

Operations possible during playback

Input source switching

Press **<SOURCE>** and **△▽** to select the input source, then press **[ENTER]**, **<▶/|| ENTER>** or **▷**.

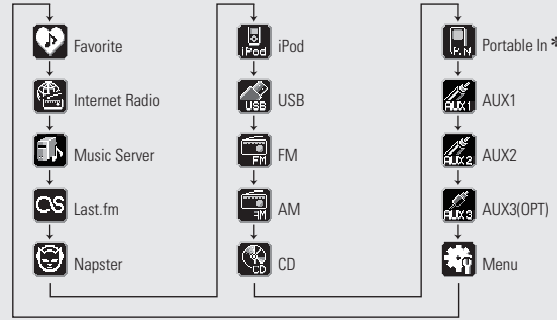

* "Portable In" appears only when the portable audio player is connected to portable in jack.

Press **[Input source select]** (**[FAVORITE]**, **[INTERNET RADIO]**, **[MUSIC SERVER]**, **[ONLINE MUSIC]**, **[iPod]**, **[USB]**, **[TUNER]**, **[CD]** or **[AUX]**).

Adjusting the master volume

Press **VOLUME ▲▼**.
The volume level is displayed.

[Adjustable range]

VOLUME 0 - 60 Default is "3".

Muting the sound

Press **[MUTE]**.
"MUTING" is displayed.



To cancel, press **[MUTE]** again.
(The mute mode is also canceled when **VOLUME ▲▼** is pressed.)

Adjusting the tone

1 Use **[SDB TONE]** to select the tone parameter to be adjusted.

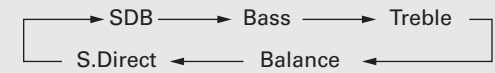

2 Adjust the volume with **<▶>**.
• To make other tone adjustments at this time, press **[SDB TONE]**.
• If no operation is performed for 5 seconds, the adjustment is retained and the normal display reappears.

SDB	Emphasize the bass sound. (Super Dynamic Bass)
[Selectable modes]	ON - OFF
BASS	Adjusts the bass sound.
[Variable range]	-10dB - +10dB
TREBLE	Adjusts the treble sound.
[Variable range]	-10dB - +10dB
BALANCE	Adjusts the left/right volume balance.
[Variable range]	L6 - CENTER - R6
S.DIRECT	The tone is not adjusted. This can also be set using (SOURCE DIRECT).

Settings made upon purchase:

- SDB.....OFF
- BASS.....0dB
- TREBLE.....0dB
- BALANCE.....CENTER



SDB, BASS and TREBLE can be set simultaneously.

Operations possible during playback

Setting the sleep timer

Use this function to automatically switch the power to the standby mode after a specific amount of time (minutes).

The sleep timer can be set to up to 90 minutes, in steps of 10 minutes.

Press [SLEEP] during playback and select the setting time.

- Press the button to select the setting time.
- After about 5 seconds, the setting is entered and the display returns to as it was before.

❑ Canceling the sleep timer

Either press [SLEEP] to select "Sleep▶OFF" or press ON/STANDBY.

❑ To check the time remaining until the sleep timer is activated

Press [SLEEP].

Switching the display's brightness

Press [DIMMER].

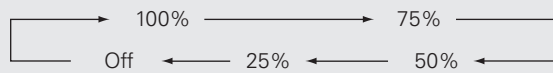

- The display's brightness switches each time the button is pressed.



If you operate the buttons when the display's brightness is set to "Off", the display temporarily lights at 25% brightness level.

Listening with headphones

Plug the headphones (sold separately) into .

- The sound from the speakers is automatically cut off.

NOTE

To prevent hearing loss, do not raise the volume level excessively when using headphones.



CD playback

This section explains how to playback CDs.

Before playing a disc

1 Press ON/STANDBY.

2 Press <SOURCE> and to select to " If no disc is loaded "No Disc" is displayed.

3 Insert a disc (page 3).

- Press to open/close the disc tray.
- The disc tray also closes when or is pressed.

NOTE



- Do not place any foreign objects in the disc tray. Doing so could damage it.
- Do not push the disc tray in by hand when the power is turned off. Doing so could damage the set.

Playing CDs

Press or .

The "



- If the input source is set to something other than "- The input source can also be switched to " page 12).

❑ Stopping playback

Press [■].

❑ Stopping playback temporarily

Press or .

 is displayed.

- To resume playback, press or .

❑ Fast-forwarding and fast-reversing (searching)

During playback, press and hold in [

❑ Moving to the beginning of tracks (skipping)

During playback, press [

- The disc skips as many tracks as times the button is pressed.
- When you press reverse once, playback returns to the beginning of the current track.

❑ To play the desired track (remote control only)

Press [NUMBER] (0 - 9, +10) to select the track.

[Example] Track 4 : [4]

[Example] Track 12 : [+10], [2]

[Example] Track 20 : [+10], [+10], [0]

Switching the display

Press [DISPLAY].

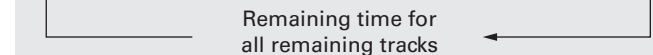
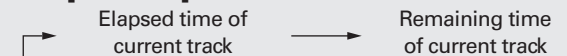

- The display switches each time the button is pressed.

Symbols used to indicate buttons in this manual

Button located on both the main unit and the remote control → **BUTTON**
 Button only on the main unit → **<BUTTON>**
 Button only on the remote control → **[BUTTON]**

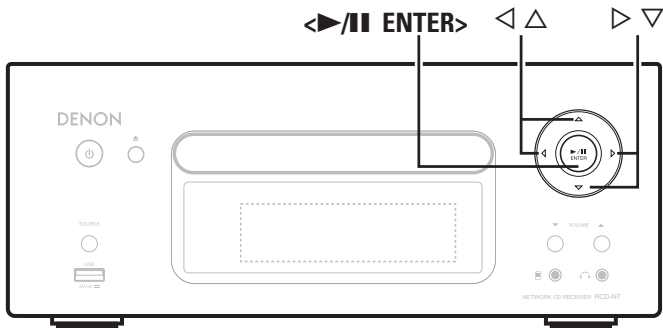

Playing repeatedly (Repeat playback)

Press **[REPEAT]**.
 Playback in the respective repeat mode starts.

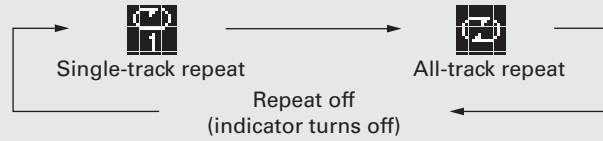

[Selectable items]

- 1 (Single-track repeat) Only 1 track plays repeatedly.
- ALL (All-track repeat) All tracks play repeatedly.
- Repeat off (indicator turns off) Normal playback resumes.

Playing random order (Random playback)

1 In the stop mode, press **[RANDOM]**.
 The “∞” is displayed.

2 Press **<ENTER>** or **[▶/||]**.
 The tracks start playing in random order.



If **[REPEAT]** is pressed during random playback, after the current session of random playback is finished, another session in a different order of tracks starts.

NOTE

Random play cannot be set or canceled during playback.

Canceling random playback

While stopped, press **[RANDOM]**.
 The “∞” turns off.

Playing tracks in the desired order (Program playback)

Up to 25 tracks can be programmed.

- 1** In the stop mode, press **[PROGRAM]**.
 “Program” is displayed.
- 2** Use **[NUMBER] (0 – 9, +10)** to select the tracks.
[Example] To program tracks 3, 12, 7 to play in that order:
 Press **[PROGRAM]**, **[3]**, **[+10]**, **[2]**, **[7]**.
- 3** Press **<ENTER>** or **[▶/||]**.
 Playback starts in the programmed order.

Checking the order of the programmed tracks

In the stop mode, press **[▶▶]**.
 The track numbers are displayed in the programmed order each time the button is pressed.

To clear the last track programmed

In the stop mode, press **[CLEAR]**.
 The last track programmed is cleared each time the button is pressed.

To clear one programmed track at a time

In the stop mode, press **[▶▶|]** to select the track to be cleared, then press **[CLEAR]**.

Clearing the all programmed track

In the stop mode, press **[PROGRAM]**.



- If **[REPEAT]** is pressed during program playback, the tracks are played repeatedly in the programmed order.
- If **[RANDOM]** is pressed during program playback, the programmed tracks are played in random order.
- The program is cleared when the disc tray is opened or the power is turned off.

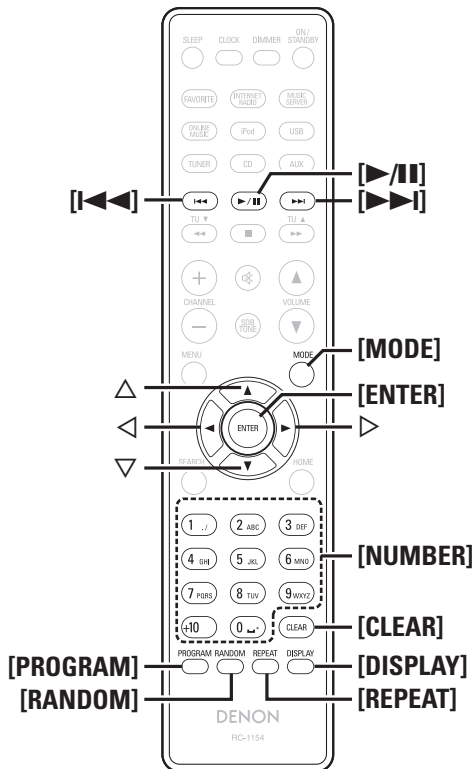

MP3 and WMA files playback

This section explains how to playback MP3 and WMA files that are recorded onto a CD-R or CD-RW. For details on how to playback files recorded onto media other than CD-R or CD-RW, see the following sections.

- ❑ **Portable audio player playback** (👉 page 23)
- ❑ **USB memory device playback** (👉 page 18)
- ❑ **iPod® playback** (👉 page 17)
- ❑ **MP3 and WMA formats** (👉 page 41)



There are many music distribution sites on the Internet allowing you to download music files in MP3 or WMA (Windows Media® Audio) format. The music (files) downloaded from such sites can be stored on CD-R or CD-RW discs and played on this unit.

“Windows Media” and “Windows” are registered trademarks or trademarks in the United States and other countries of Microsoft Corporation of the United States.

Playing files

- 1** Load a CD-R or CD-RW disc containing music files in the MP3 or WMA format into the disc tray (👉 page 3).
- 2** Press [MODE] and select “Folder” or “Disc”.

Folder ←→ Disc

[About the display]
 When “Folder” is selected.....“” is displayed.
 When “Disc” is selected.....“” turns off.

Folder	All the files in the selected folder are played.
Disc	After the selected folder and files are played, all the files in all the folders are played.
- 3** Use $\Delta \nabla$ to select the folder to be played.
- 4** Use [◀▶], [⏪▶▶] or ◀ ▶ to select the file to be played.
- 5** Press [▶/||], [ENTER] or ◀▶/|| ENTER>.

❑ To switch the folder or file during playback

Folder

Use $\Delta \nabla$ to select the folder, then press [ENTER] or ◀▶/|| ENTER>.

File

Use ◀ ▶ to select the file, then press [ENTER] or ◀▶/|| ENTER>. Also use [⏪▶▶] to select the file, or use [NUMBER] (0 – 9, +10) to select the file number.

- The folder and file numbers are set automatically when the disc is loaded.



- Copyright-protected files cannot be played.
- Depending on the application software used for writing, it may not be possible to write the data properly.
- Depending on the disc’s recording conditions, it may not be possible to play some discs properly.

❑ Switching the display

During playback, press [DISPLAY].

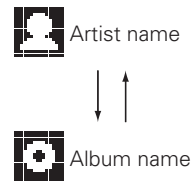

❑ To play repeatedly

Press [REPEAT].

Playback starts in the respective repeat mode.

- The selectable repeat modes differ in the “Folder” and the “Disc”.

When “Folder” is selected:

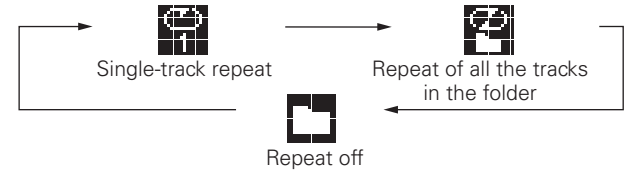

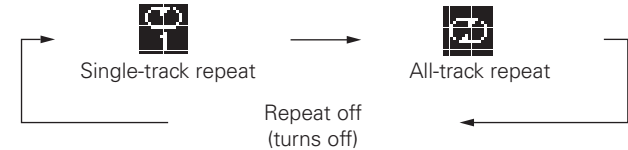

When “Disc” is selected:



[Selectable items]

When “Folder” is selected:

-  Only the selected track is played repeatedly.
-  All the files in the selected folder are played repeatedly.
-  Folder playback resumes.

When “Disc” is selected:

“Playing repeatedly (Repeat playback)” (👉 page 14)

❑ Setting random playback

“Playing random order (Random playback)” (👉 page 14)



Programmed playback is not possible with MP3/WMA discs.

Symbols used to indicate buttons in this manual

- Button located on both the main unit and the remote control → **BUTTON**
- Button only on the main unit → **<BUTTON>**
- Button only on the remote control → **[BUTTON]**

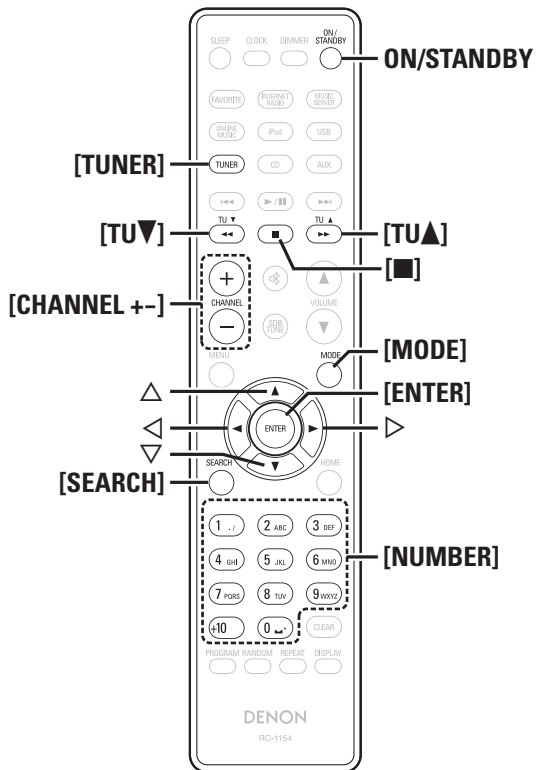
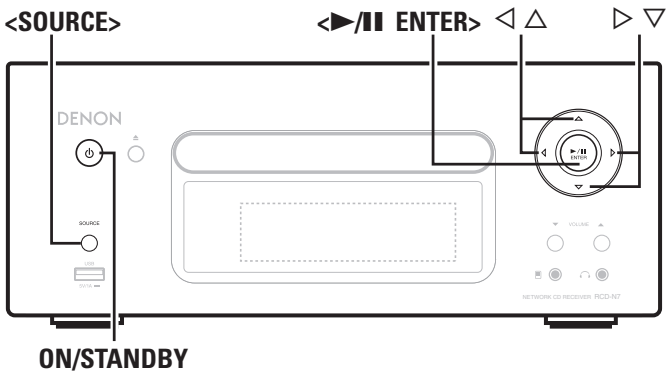

Tuner playback

Tuning in Broadcast Stations

Connect the antenna beforehand (page 7).

1 Press **[TUNER]** to select the reception band.

AM ↔ FM

2 Tune in the desired broadcast station. (FM/AM only)
When a station is received, the "FM" will light.

1 To tune in automatically (Auto tuning)

Press **[MODE]** to light the "AUTO" indicator on the display, then use **[TU ▲, TU ▼]** to select the station you want to hear.

2 To tune in manually (Manual tuning)

Press **[MODE]** to turn off the display's "AUTO" indicator, then use **[TU ▲, TU ▼]** to select the station you want to hear.



- If the input source is set to something other than "TUNER", press **[TUNER]** to switch the input source to "TUNER".
- The input source can also be switched to "FM" or "AM" using **<SOURCE>** (page 12).
- If the desired station cannot be tuned in with auto tuning, tune it in manually.
- When tuning in stations manually, press and hold **[TU ▲, TU ▼]** to change frequencies continuously.
- A humming sound may be heard when using a TV nearby while receiving AM programs. If this happens, move the system as far from the TV as possible.

To stop auto tuning

Press **[TU ▲, TU ▼]**.

Automatically presetting FM stations (Auto preset)

This unit can be preset with a total of 99, FM and AM broadcast stations.

NOTE

Auto preset is not possible with AM broadcast stations.

Auto presetting with the remote control

Perform this operation when tuned to an FM broadcast station.

1 Press **[SEARCH]**.

"Search" menu appears.

2 Use **▲ ▼** to select "Auto Preset" – "Start", then press **[ENTER]**, **<>/|| ENTER>** or **>**.

After "Searching" is displayed, "Complete" is displayed.

Canceling auto presetting

Press **[■]**.



Broadcast stations whose antenna signal are weak cannot be preset automatically. If you wish to preset such stations, tune them in manually.

NOTE

When the auto presetting operation is performed, the new presettings overwrite the previous presettings.

Giving station names to preset channels

Names of up to 8 characters can be input.

1 Tune in the preset channel you want to name.

2 Press and hold **[ENTER]** or **<>/|| ENTER>**.
The display switches to the station name input display.

3 Input the station name.
"Inputting characters" (page 34)

4 Press **[ENTER]** or **<>/|| ENTER>**.
The characters you have input are entered.
• To give names to other stations, repeat steps 1 to 4.

Presetting FM/AM stations manually

This unit can be preset with a total of 99 FM and AM broadcast stations.

- 1** Tune in the station you want to preset.
- 2** Press [ENTER] or <▶/|| ENTER>. "Preset" menu appears.
- 3** Use △▽ to select "Add to Preset", then press [ENTER], <▶/|| ENTER> or ▷.
- 4** Use △▽ to select the number to be preset, then press [ENTER] or <▶/|| ENTER>. The reception frequency and reception mode are preset and the display switches to the station name input display.
- 5** Input the station name.
"Inputting characters" (☞ page 34)
 - If you do not want to input a station name, press [ENTER] or <▶/|| ENTER> without inputting anything else.
 - If you make a mistake when inputting, perform the procedure again. Whatever was previously input is overwritten.
- 6** Press [ENTER] or <▶/|| ENTER>. The characters you have input are entered.
 - To give names to other stations, repeat steps 1 to 5.

Listening to preset stations

Use [NUMBER] (0 – 9, +10) or [CHANNEL + –] to select the preset number.

Tuner playback

Calling stations registered in Preset List

- 1** Press [ENTER] or <▶/|| ENTER>. "Preset" menu appears.
- 2** Use △▽ to select "Call Preset", then press [ENTER], <▶/|| ENTER> or ▷. The Preset list appears.
- 3** Use △▽ to select Preset List, then press [ENTER], <▶/|| ENTER> or ▷.

Deleting stations registered in Preset List

- 1** Press [ENTER] or <▶/|| ENTER>. "Preset" menu appears.
- 2** Use △▽ to select "Delete Preset", then press [ENTER], <▶/|| ENTER> or ▷. The Preset list appears.
- 3** Use △▽ to select Preset List, then press [ENTER], <▶/|| ENTER> or ▷.
- 4** When the prompt "Delete?" appears, press [ENTER] or <▶/|| ENTER>.

- To cancel the operation, press ◀.



iPod® playback

With this unit, you can listen to music on an iPod. It is also possible to operate the iPod from the main unit or remote control. For the supported iPod models, see "Connecting an iPod" (☞ page 9).

☐ iPod® (☞ page 41)

Before playing an iPod

- 1** Press ON/STANDBY.
- 2** Load the iPod onto the iPod dock of this unit. When the iPod is loaded to the iPod dock on this unit, the input source automatically switches to "iPod" and file playback begins.

NOTE

This function is activated around 1 or 2 minutes after the power is turned on.

Playing an iPod

- 1** Press [MODE] to select the display mode. The mode switches each time the button is pressed.
 - There are two modes for displaying the contents recorded on the iPod.
 - Browse mode** Display iPod information on the display of this unit.
 - Remote mode** Display iPod information on the iPod screen.
 - "Remote iPod" is displayed on the display of this unit.

Display mode		Browse mode	Remote mode
Display location		Main unit display	iPod display
Playable files	Audio file	✓	✓
	Video file		✓
Active buttons	Remote control and main unit	✓	✓
	iPod®		✓

- The default display mode setting is "Browse mode".

- 2** Use △▽ to select the item, then press [ENTER] or <▶/|| ENTER> to select the music file to be played.
- 3** Press [▶/||] or <▶/|| ENTER>. Playback starts.

Symbols used to indicate buttons in this manual

- Button located on both the main unit and the remote control → **BUTTON**
- Button only on the main unit → **<BUTTON>**
- Button only on the remote control → **[BUTTON]**

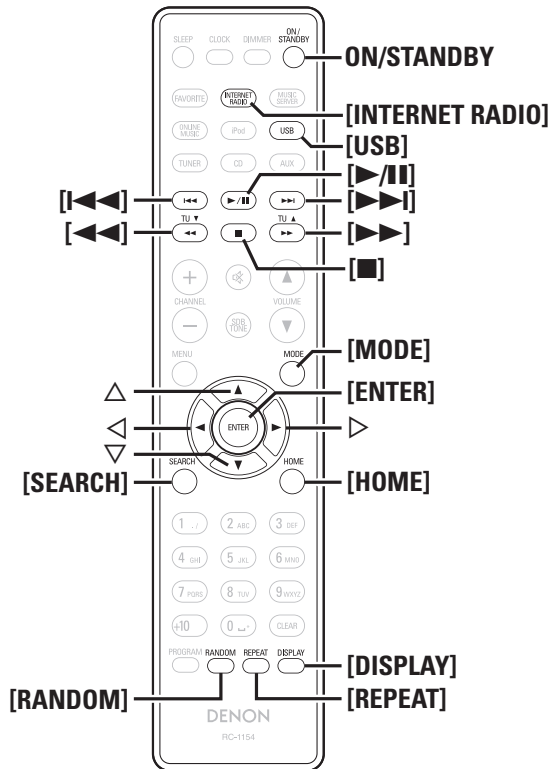
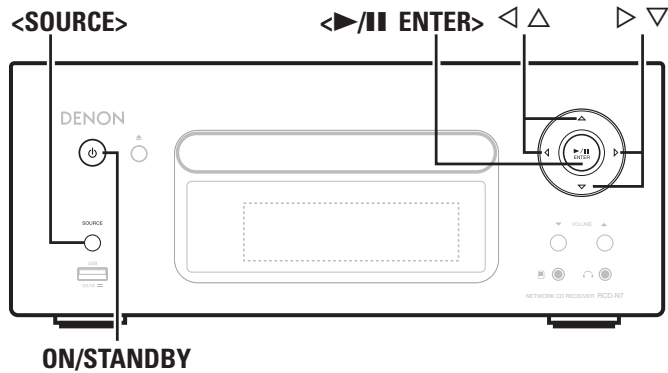

iPod® playback

NOTE

- iPod nano 1G and iPod video do not have remote mode support.
- DENON will accept no responsibility whatsoever for any loss of iPod data.
- Depending on the type of iPod and the software version, some functions may not operate.

Remote control and iPod button relations

Remote control buttons	iPod buttons	Operation on this unit
▶/	▶	Play the track / Pause the track.
◀◀, ▶▶	◀◀, ▶▶	Play the track from the beginning/Play the next track.
◀◀, ▶▶ Press and hold	◀◀, ▶▶ Press and hold	Fast-reverse the track/Fast-forward the track.
△, ▽	Click Wheel	Select an item.
ENTER or ▷	Select	Enter the selection or plays the track.
MODE	-	Switch between the browse mode and the remote mode.
REPEAT	-	Switch the repeat function
RANDOM	-	Switch the shuffle function
◀	MENU	Display the menu or return to the previous menu.
■	-	Stop the track.
HOME	-	Return to top menu (in Browse mode)

To switch the display

During playback, press [DISPLAY].
The display switches each time the button is pressed.

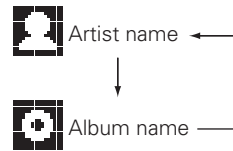

Disconnecting the iPod

- 1 Press **ON/STANDBY** to set the standby mode.
- 2 Remove the iPod from the iPod dock of this unit.

USB memory device playback

Playing back music or files recorded on a USB memory device or an iPod.

- ❑ **USB memory device** (page 42)
- ❑ **Playing an iPod** (page 17)

Before playing a USB memory device or an iPod

- 1 Press **ON/STANDBY**.
- 2 Connect **USB memory device or iPod connection cable**.
- 3 Press **<SOURCE>** and **△ ▽** to select to “**USB**”, then press **[ENTER]**, **<▶/|| ENTER>** or **▷**, or press **[USB]**.

NOTE

This function is activated around 1 or 2 minutes after the power is turned on.

Playing files stored on USB memory devices

- 1 Press **△ ▽** to select the search item or folder, then press **[ENTER]**, **<▶/|| ENTER>** or **▷**.
- 2 Press **△ ▽** to select the file, then press **[ENTER]**, **<▶/|| ENTER>**, **▷** or **[▶/||]**. Playback starts.

- If the USB memory device is divided into multiple partitions, only the top partition can be selected.
- This unit is compatible with MP3 files conforming to “MPEG-1 Audio Layer-3” standards.

USB memory device playback

NOTE

- Note that DENON will accept no responsibility whatsoever for any problems arising with the data on a USB memory device when using this unit in conjunction with the USB memory device.
- USB memory devices will not work via a USB hub.
- DENON does not guarantee that all USB memory devices will operate or be supplied power. When using a USB portable hard disk that can draw power from an AC adapter, we recommend using the AC adapter.
- It is not possible to connect and use a computer via the USB port of this unit using a USB cable.

USB operation

Operation buttons	Operation on this unit
	Play the track / Pause the track.
	Play the track from the beginning/Play the next track.
	Select an item.
ENTER or	Enter the selection or plays the track.
REPEAT	Switch the repeat function
	Display the menu or return to the previous menu.
	Stop the track.
SEARCH	Character search*
HOME	Return to top menu

- **Playing repeatedly (Repeat playback)** (👉 page 14)

* Press **[SEARCH]**, then press to select the first letter you want to search mode.

If the list is not in alphabetical order, you may not be able to perform a character search.

To switch the display

During playback, press **[DISPLAY]**.

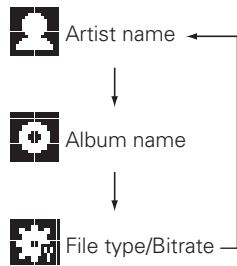

Network audio playback

Follow this procedure to play Internet radio stations or music files stored on a computer.

- ❑ **About the internet radio function** (👉 page 43)
- ❑ **Music server** (👉 page 43)
- ❑ **About Napster** (👉 page 43)
- ❑ **About Last.fm** (👉 page 43)

Listening to internet radio

- 1 Prepare for playback.**
 - ① Check the network environment, then turn on this unit's power (👉 page 11 "Turning the power on").
 - ② If settings are required, make the "Setting the network [Network]" (👉 page 28).
- 2 Press [INTERNET RADIO].**
- 3 Press to select the item you want to play, then press [ENTER], [ENTER] or .**
- 4 Repeat step 3 until the station list is displayed.**
The station list is displayed.
- 5 Press to select the station, then press [ENTER], [ENTER] or .**
Playback starts once buffering reaches "100%".

- There are many Internet radio stations on the Internet, and the quality of the programs they broadcast as well as the bit rate of the tracks varies widely. Generally, the higher the bit rate, the higher the sound quality, but depending on the communication lines and server traffic, the music or audio signals being streamed may be interrupted. Inversely, lower bit rates mean a lower sound quality but less tendency for the sound to be interrupted.
- "Server Full" or "Connection Down" is displayed if the station is busy or not broadcasting.
- On this unit, folder and file names can be displayed as titles. Any characters that cannot be displayed are replaced with "." (period).
- When **[DISPLAY]** is pressed, the display can be switched between the file type/bitrate and radio station name.

Switching the display

- 1 Press [DISPLAY] during Internet radio reception.**
- 2 The broadcast station information and signal format bit rate are displayed.**

Recently played internet radio stations

Recently played internet radio stations can be selected from "Recently Played".
Up to 20 stations stored in "Recently Played".

- 1 Press to select "Recently Played", then press [ENTER], [ENTER] or .**
- 2 Press to select the item you want to play, then press [ENTER], [ENTER] or .**

Searching stations by keyword (Alphabetic strings)

- 1 Press to select "Search by Keyword", then press [ENTER] or .**
• For character input, see page 34.
- 2 Input the characters, then press [ENTER] or [ENTER].**

Registering internet radio stations as your favorites

You can register your favorite broadcast stations in Favorite List. (👉 page 23)

❑ Music server operation

Operation buttons	Function
MENU	Menu
△▽◀▶	Cursor operation / Auto search (cue, △▽)
ENTER	Enter
SEARCH	Character search *
HOME	Return to top page
▶/	Playback / Pause
◀◀ ▶▶	Auto search (cue)
■	Stop
FAVORITE	Register or call your favorite file in Favorite List, and delete file from the list.

- **Playing repeatedly (Repeat playback)** (🔗 page 14)
- **Playing random order (Random playback)** (🔗 page 14)

* Press **[SEARCH]**, then press ◀▶ to select the first letter you want to search mode.

✎ If the list is not in alphabetical order, you may not be able to perform a character search.

Listening to Last.fm 

Last.fm radio is not available in all countries. Please check www.last.fm/hardware for more information. You'll also need a subscription. Get one today at www.last.fm/subscribe.

1 Prepare for playback.

- ① Make sure this unit is connected to the Internet, then turn on this unit's power (🔗 page 11 "Turning the power on").
- ② If settings are required, make the "Setting the network [Network]" (🔗 page 28).

2 Press [ONLINE MUSIC] then select "Last.fm".

- If you do not have a Last.fm account, press ▾ to select "I am new to Last.fm". Then press **[ENTER]**, ◀▶/|| **ENTER**> or ▶.
- Create an account in accordance with the instructions on the display.

3 If you have a Last.fm account, press △▽ to select "I have a Last.fm account". Then press [ENTER], ◀▶/|| **ENTER> or ▶.**

4 Use △▽▶ to enter your username and password.

- For character input, see page 34.

5 After inputting the username and password, select "login", then press [ENTER] or ◀▶/|| **ENTER>.**

If the username and password match, the top menu for Last.fm is displayed.

- The types of characters that can be input are as shown below.

❑ Username
[Upper case characters] ABCDEFGHIJKLMN OPQRSTUVWXYZ
[Lower case characters] abcdefghijklmnopqrstuvwxyz
[Symbols] _ -
[Numbers] 0123456789
❑ Password
[Upper case characters] ABCDEFGHIJKLMN OPQRSTUVWXYZ
[Lower case characters] abcdefghijklmnopqrstuvwxyz
[Symbols] ! # " \$ % & ' () * + , - . / : ; < = > ? @ [\] ^ ` { } ~ (Space)
[Numbers] 0123456789

6 Use △▽ to select menu and then press [ENTER], ◀▶/|| **ENTER> or ▶.**

Popular Stations : Play popular artists and tags in your area.

You Recent Stations : Play your recent stations.

Your stations : You can play tracks from the following personalised stations ("Your Recommended Radio", "Your Library", "Your Neighborhood", "Your Friends' Radio", "Your Top Tags", "Your Top Artists").

Search Stations : You can search station by Artist or Tag.

7 Use △▽ to select a station, and press [ENTER], ◀▶/|| **ENTER> or ▶ or ▶/|| to start playback.**
Playback starts.

8 When you press ▶ during playback, the following menu appears.

Love this track : Loving tracks improves your Last.fm recommendations, and you can optionally share them on popular social networks.

Ban this track : If you ban a track, we won't play it again. You can undo this on the Last.fm website.

Scrobbling : Scrobbling sends the tracks you played to your Last.fm account. You can see charts of the music you've been listening to, get recommendations for new music and events in your area and share your listening tastes with your friends. You can turn this service on or off using this option. The more you scrobble, the better your recommendations will become.

NOTE

- The password should be no longer than 90 characters
- Press **[HOME]** to cancel the input.



Use **[DISPLAY]** to switch between displaying the artist name, file type/bitrate or album name.

❑ Last.fm operation

Operation buttons	Function
MENU	Menu
△▽◀▶	Cursor operation / Auto search (cue, ▾)
ENTER	Enter
HOME	Return to top page
▶/	Playback
▶▶	Auto search (cue)
■ (or ▶/ ENTER (main unit))	Stop

Symbols used to indicate buttons in this manual

Button located on both the main unit and the remote control → **BUTTON**
 Button only on the main unit → **<BUTTON>**
 Button only on the remote control → **[BUTTON]**

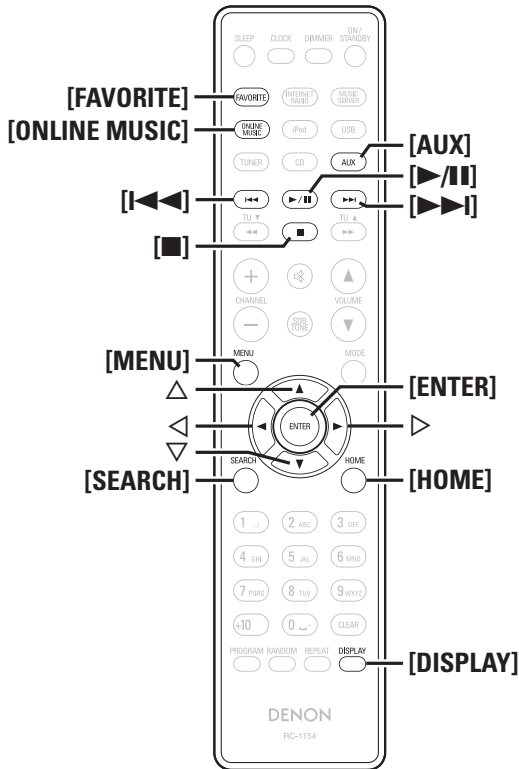
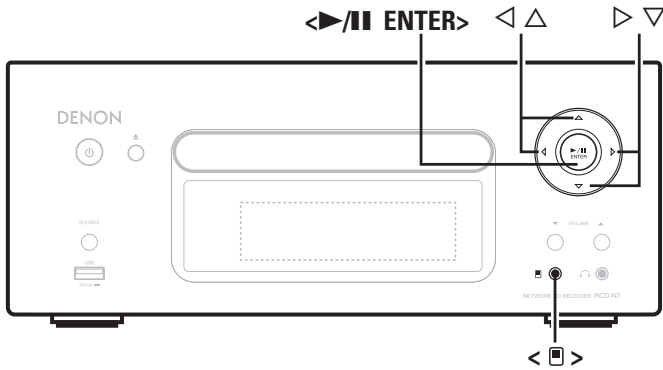

Listening to Napster

Napster is not available in all countries.

- 1 Prepare for playback.**
 - Check the network environment, then turn on this unit's power (☞ page 11 "Turning the power on").
 - If settings are required, make the "Setting the network [Network]" (☞ page 28).
- 2 Press [ONLINE MUSIC] and select "Napster".**
- 3 Use Δ ∇ \triangleright to input "Username" and "Password".**
 - For character input, see page 34.
- 4 After inputting the "Username" and "Password", select "login", then press [ENTER] or \blacktriangleleft /|| ENTER>.**

If the "Username" and "Password" match, the top menu for Napster is displayed.

NOTE

- The password should be no longer than 99 characters.
- Press [HOME] to cancel the input.

Searching from Napster menu

- 1 Use Δ ∇ to select search item or folder, then press [ENTER], \blacktriangleleft /|| ENTER or \triangleright .**
- 2 Repeat step 1 until the track is displayed.**
- 3 Use Δ ∇ to select the track item, then press [ENTER], \blacktriangleleft /|| ENTER or \triangleright .**

Entering a character search for the track you want to listen to

- 1 Press [SEARCH].**
 - You can search by artist name, album name or track name in menu list.
 - You cannot perform search on the playback screen.

- 2 Use Δ ∇ to select the search item, then press [ENTER], \blacktriangleleft /|| ENTER.**
 The search display appears.

- For character input, see page 34.

- 3 Input the characters, then press [ENTER] or \blacktriangleleft /|| ENTER.**

Registering tracks in my Napster library

- 1 Press \triangleright while the track you wish to register is playing.**
 "Add to my library?" appears.
- 2 Press [ENTER], \blacktriangleleft /|| ENTER or \triangleright .**
 The track is entered in the Library.
 When you press \blacktriangleleft , the registration is cancelled and the display returns to the previous page.

Listening to tracks registered in my Napster library

- 1 Use Δ ∇ to select "My Napster Library", then press [ENTER], \blacktriangleleft /|| ENTER or \triangleright .**
- 2 Use Δ ∇ to select the information or track, then press [ENTER], \blacktriangleleft /|| ENTER.**



Use [DISPLAY] to switch between displaying the artist name, file type/bitrates or album name.

Napster operation

Operation buttons	Function
MENU	Menu
Δ ∇ \blacktriangleleft \triangleright	Cursor operation / Auto search (cue, Δ ∇)
ENTER	Enter
SEARCH	Search menu
HOME	Return to top page
\blacktriangleleft/ 	Playback
\blacktriangleleft \triangleright	Auto search (cue)
■	Stop

- Playing repeatedly (Repeat playback)** (☞ page 14)
- Playing random order (Random playback)** (☞ page 14)

Portable audio player playback

Your portable audio player can be connected to this unit's portable jack to play tracks on the portable audio player.

Playing portable audio player

- 1 Connect the portable audio player to  (page 10 “Connecting a portable player”).**
The input source automatically switches to “Portable In”.
- 2 Play the portable audio player.**
The player's audio is output.
 - Also read the portable audio player's operating instructions.

NOTE

When using the portable player's headphone jack, set the volume on the portable player to an appropriate level.

Listening to AUX

- 1 Prepare for playback.**
Check the connection, then turn on this units.
- 2 Press [AUX] to select “Portable In”, “AUX1”, “AUX2” or “AUX3”.**



- When there is no portable audio player connected to the portable in jack, “Portable In” is not displayed when you press [AUX].

- 3 Play the component connected to this unit.**

Favorite function

This section provides information on the Favorite function.

- The Favorite function allows you to register your favorite broadcast stations and files in Favorite List in advance so that you can call and listen to the stations or files right away, whenever you want.
- The contents that you can register and call are Internet radio station, music server, and tuner.
- You can register up to 50 items in Favorite List.
- When you attempt to register the 51st station in Favorite List, the last station (station that is accessed least frequently) is automatically deleted.
- When you select a station from Favorite List, the top of the list is displayed.

Registering Internet radio stations, music servers and tuners in Favorite List

- 1 Press [FAVORITE] while the Internet radio station, tuners or file to register is played back.**
“Favorite” menu appears.
- 2 Use Δ / ∇ to select “Add to Favorite”, then press [ENTER], \blacktriangleleft / \blacktriangleright [ENTER] or \blacktriangleright .**
When the station, server, or tuner is registered, “Add to Favorite” appears.

Calling Internet radio stations, files registered or tuners in Favorite List

- 1 Press [FAVORITE].**
“Favorite” menu appears.
- 2 Use Δ / ∇ to select “Call Favorite”, then press [ENTER], \blacktriangleleft / \blacktriangleright [ENTER] or \blacktriangleright .**
The Favorite list appears.
- 3 Use Δ / ∇ to select Favorite List, then press [ENTER], \blacktriangleleft / \blacktriangleright [ENTER] or \blacktriangleright .**
The respective function starts up and playback starts.

Deleting Internet radio stations, files registered or tuners in Favorite List

- 1 Press [FAVORITE].**
“Favorite” menu appears.
- 2 Use Δ / ∇ to select “Delete Favorite”, then press [ENTER], \blacktriangleleft / \blacktriangleright [ENTER] or \blacktriangleright .**
The Favorite list appears.
- 3 Use Δ / ∇ to select Favorite List, then press [ENTER], \blacktriangleleft / \blacktriangleright [ENTER] or \blacktriangleright .**
- 4 When the prompt “Delete?” appears, press [ENTER] or \blacktriangleleft / \blacktriangleright [ENTER].**
 - To cancel the operation, press \blacktriangleleft .

Advanced operations

Symbols used to indicate buttons in this manual

- Button located on both the main unit and the remote control → **BUTTON**
- Button only on the main unit → **<BUTTON>**
- Button only on the remote control → **[BUTTON]**

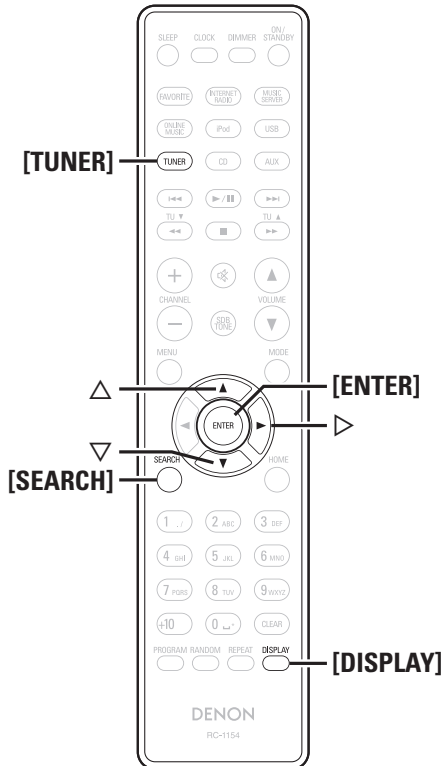
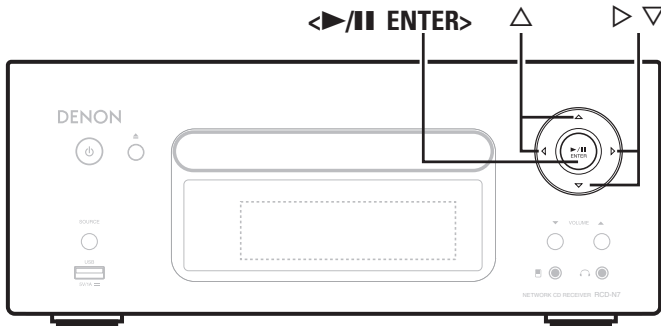

Tuner playback

RDS (Radio Data System)

RDS (works only on the FM band) is a broadcasting service which allows a station to send additional information along with the regular radio program signal. The following four types of RDS information can be received with this unit:

□ RDS Search

Use this function to automatically tune to FM stations that provide the RDS service.

- 1 Press **[TUNER]** to select “FM”.
- 2 Press **[SEARCH]**.
- 3 Use **△▽** to select “RDS SEARCH”, then press **[ENTER]**, **<▶/|| ENTER>** or **▷**.
Automatically begin the RDS search operation.
• If no RDS station is found, “No Program” is displayed.

Viewing information during reception

Press **[DISPLAY]** while receiving a RDS to display the information currently being broadcast.



- *1 Frequency
- *2 Program service name
- If a station name is entered, it is displayed.

PTY (Program Type)

PTY identifies the type of RDS program. The program types and their displays are as follows:

NEWS	News	WEATHER	Weather
AFFAIRS	Current Affairs	FINANCE	Finance
INFO	Information	CHILDREN	Children's programmes
SPORT	Sports	SOCIAL	Social Affairs
EDUCATE	Education	RELIGION	Religion
DRAMA	Drama	PHONE IN	Phone In
CULTURE	Culture	TRAVEL	Travel
SCIENCE	Science	LEISURE	Leisure
VARIED	Varied	JAZZ	Jazz Music
POP M	Pop Music	COUNTRY	Country Music
ROCK M	Rock Music	NATION M	National Music
EASY M	Easy Listening Music	OLDIES	Oldies Music
LIGHT M	Light Classical	FOLK M	Folk Music
CLASSICS	Serious Classical	DOCUMENT	Documentary
OTHER M	Other Music		

□ PTY search

Use this function to find RDS stations broadcasting a designated program type (PTY). For a description of each program type, refer to “PTY (Program Type)”.

- 1 Press **[TUNER]** to select “FM”.
- 2 Press **[SEARCH]**.
- 3 Use **△▽** to select “PTY SEARCH”, then press **[ENTER]**, **<▶/|| ENTER>** or **▷**.
- 4 Use **△▽** to call out the desired program type, then press **[ENTER]**, **<▶/|| ENTER>** or **▷**.
Automatically begin the PTY search operation.
• If no program of the specified type is found, “No Program” is displayed.

Tuner playback

TP (Traffic Program)

TP identifies programs that carry traffic announcements.

This allows you to easily find out the latest traffic conditions in your area before leaving home.

TP search

Use this function to find RDS stations broadcasting traffic programs (TP stations).

1 Press [TUNER] to select “FM”.

2 Press [SEARCH].

3 Use Δ / ∇ to select “TP SEARCH”, then press [ENTER], \leftarrow /[II ENTER] or \triangleright .

Automatically begin the TP search operation.

- “No Program” is displayed when there is no traffic information broadcast station.

RT (Radio Text)

RT allows RDS stations to send text messages that appear on the display.







- When the RT mode is turned on while an RDS broadcast station not offering an RT service is tuned in, “NO TEXT” is displayed on the display.
- The RT mode cannot be set in the AM band or for FM stations not offering RDS broadcasts.

NOTE

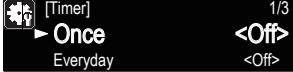
The operations described below selecting “RDS Search” will not function in areas in which there are no RDS broadcasts.

Menu map

Setting items	Detailed items	Description	Page		
Timer 	Once	Set Time (hh:mm)	Performs the time setting of Once Timer that is activated at a specified time.	26	
		Source (xxx)	Performs the playback Source (input source) setting of Once Timer to be activated at a specified time.	26	
		Volume (xx)	Performs the playback Volume setting of Once Timer to be activated at a specified time.	26	
	Everyday	Set Time (hh:mm)	Performs the time setting of Everyday Timer that is activated everyday.	26	
		Source (xxx)	Performs the playback Source (input source) setting of Everyday Timer to be activated everyday.	26	
		Volume (xx)	Performs the playback Volume setting of Everyday Timer to be activated everyday.	26	
Clock 	Auto Adjust	Time Zone	Automatically performs the clock setting from the time information on the Internet.	11	
		Summer Time	Sets your local time zone (for Auto Adjust).	27	
		Adjust Now	Sets the Summer Time information (for Auto Adjust).	27	
	Manual Adjust	Obtains the current time.	27		
	Network First Setup		Adjusts the clock manually.	27	
	Network First Setup		Performs the network settings using a Wizard style window.	–	
Network 	Connection	Wired		Performs the wired connection settings.	28
		DHCP	Performs the DHCP setting.	28	
		IP Address	Performs the IP address setting.	28	
		Subnet Mask	Performs the subnet mask setting.	28	
		Gateway	Performs the gateway setting.	28	
		Primary DNS	Performs the primary DNS setting.	28	
		Secondary DNS	Performs the secondary DNS setting.	28	
		Proxy	Performs the proxy setting.	29	
		Connection	Performs the connection test.	28	
		Wireless		Selects and sets the wireless connections from the access point list.	29
	Search Access Point	Sets the wireless connection using WPS.	29		
	WPS	Sets the wireless connection manually.	30		
	Manual Setting	Performs the Last.fm account setting again.	21		
	Last.fm Account		Performs the Napster account setting again.	22	
	Napster Account		Disables the display of Last.fm on the menu.	30	
	Last.fm Display		Starts or stops the party mode.	31	
	Party Mode	Party Mode Function		Enable/disable the party mode.	31
Party Start Level		Sets the volume used for the party mode.	31		
		Performs other network settings.	–		
Other Network	Network Standby		Sets the network function on during standby.	32	
	PC Language		Selects the language to be used for displaying the Internet sites.	32	
	Friendly Name Edit		Edits a name displayed on the Internet.	32	
	Network Status		Displays the statuses of up to 10 DENON products connected to the same network.	32	
Network Info.		Displays various setting values of the network.	–		
Other 	Auto Standby		Sets the Auto Standby mode to automatically enter standby when no operation is performed.	33	
	Screen Saver		Activates the screen saver.	33	
	Speaker Optimize		Performs the filter setting for optimizing the response of optional speakers if they are connected.	33	
	Firmware Update		Starts the firmware update.	33	

Hand icon Symbols used to indicate buttons in this manual

- Button located on both the main unit and the remote control → **BUTTON**
- Button only on the main unit → **<BUTTON>**
- Button only on the remote control → **[BUTTON]**

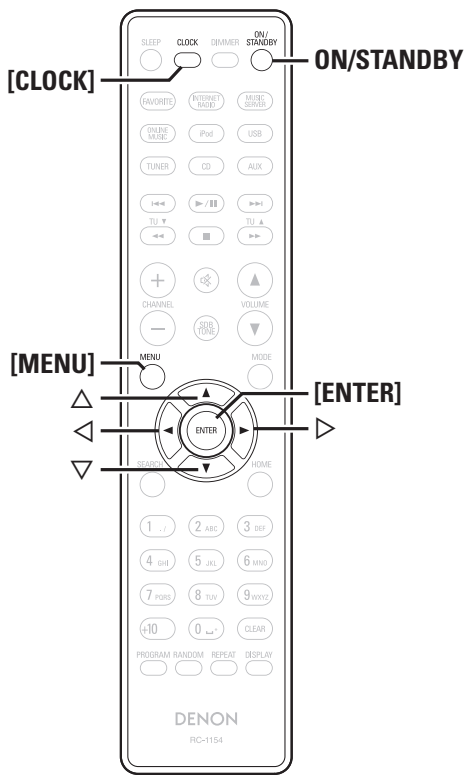
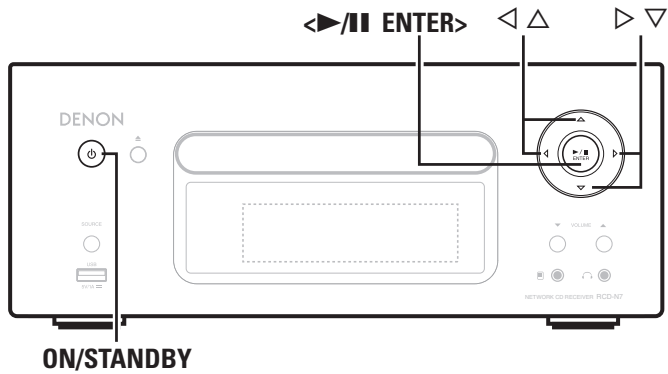

Setting the timer [Timer]

This device can playback using the timer playback (everyday timer, once timer).

- This unit's timer does not support exit time settings for timer playback.

Timer operation when the time settings for timers overlap

When the once timer and everyday timer are both set (sleep timer is not set)

- Automatically starts playback at the earlier timer start time set for either of the timers.

If the current time is not set, enter timer setting mode to get time setting mode.

Setting the everyday timer and once timer

- Everyday timer ("Everyday")**
Playback starts at the set times each day.
- Once timer ("Once")**
Playback starts once only at the set times.

- Press **[MENU]**.
Turns on the Menu settings mode and the Menu appears on the display. (☞ page 25 "Menu map")
- Use Δ / ∇ to select "Timer", then press **[ENTER]**, **<▶/|| ENTER>** or **▶**.
- Use Δ / ∇ to select the timer mode, and use Δ / ∇ to select "On" or "Off" then press **[ENTER]**, or **<▶/|| ENTER>**.
- Use Δ / ∇ to select "Set Time", then press **[ENTER]**, **<▶/|| ENTER>** or **▶**.
- Use Δ / ∇ to select "hours" – "minutes" for the timer start time, then press **[ENTER]**, **<▶/|| ENTER>** or **▶**.
- Use Δ / ∇ to select "Source", then press **[ENTER]**, **<▶/|| ENTER>** or **▶**.

7 Use Δ / ∇ to select the input source, then press **[ENTER]**, **<▶/|| ENTER>** or **▶**.

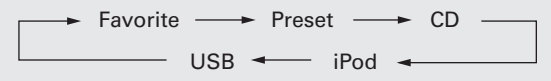

8 Use Δ / ∇ to select the "Volume", then press **[ENTER]**, **<▶/|| ENTER>** or **▶**.

9 Use Δ / ∇ to select the volume "0 – 60", then press **[ENTER]**, **<▶/|| ENTER>** or **▶**.

10 Press **ON/STANDBY** to set the power to standby.
Timer standby mode is set, and the power indicator lights orange.

NOTE

- If the unit or remote control is not operated for 90 minutes or more when the timer is set to on, the standby mode is activated.
- When using timer playback on an iPod Touch or iPhone, set the iPod Touch or iPhone to "Sleep" mode. If the power is switched off using the power off operation, timer playback cannot be used. For details on the "Sleep" mode of the iPod Touch or iPhone, see the instruction manuals of the products or related web pages.

- Setting the timer to on or off**
Perform the operations at "Setting the timer [Timer]" (☞ page 26).
• When set to "OFF", time operation is disabled, but the timer settings remain unchanged.
- To check the timer settings**
Perform the operations at "Setting the timer [Timer]" (☞ page 26).
- To change the timer settings**
Perform the operations at "Setting the timer [Timer]" (☞ page 26).
- To change the setting while setting the timer**
Press Δ .
The setting returns to the previous step. Display the setting you want to change, then make the desired setting.



Adjusting the clock automatically [Clock]

You can automatically adjust the clock of this unit using the Internet.



To use this function, the unit must be connected to the Internet.

Setting the Time Zone

Use the following procedure to select your local standard time (time zone).

- 1 Press [MENU].**
Turns on the Menu settings mode and the Menu appears on the display. (☞ page 25 "Menu map")
- 2 Use Δ / ∇ to select "Clock" – "Auto Adjust" – "Time Zone", then press [ENTER], \blacktriangleleft / \blacktriangleright [ENTER] or \blacktriangleright .**
"Time Zone" menu appears.
- 3 Use Δ / ∇ to select your time zone, then press [ENTER], \blacktriangleleft / \blacktriangleright [ENTER] or \blacktriangleright .**
The setting is entered.

Setting the Summer Time

Use the following procedure to set Summer time if the Summer time system is used in your country.

- 1 Press [MENU].**
Turns on the Menu settings mode and the Menu appears on the display. (☞ page 25 "Menu map")
- 2 Use Δ / ∇ to select "Clock" – "Auto Adjust" – "Summer Time", then press [ENTER], \blacktriangleleft / \blacktriangleright [ENTER] or \blacktriangleright .**
"Summer Time" menu appears.
- 3 Use Δ / ∇ to select "Off (0H)" or "On (+1H)", then press [ENTER], \blacktriangleleft / \blacktriangleright [ENTER] or \blacktriangleright .**
The setting is entered.

Auto Adjust

Use the following procedure to automatically adjust the clock.

- 1 Press [MENU].**
Turns on the Menu settings mode and the Menu appears on the display. (☞ page 25 "Menu map")
- 2 Use Δ / ∇ to select "Clock" – "Auto Adjust" – "Adjust Now", then press [ENTER], \blacktriangleleft / \blacktriangleright [ENTER] or \blacktriangleright .**
The operation to receive the current time starts.
 - The current time is displayed for several seconds when it is received successfully.
 - If the current time is not received successfully, "Connection Failed" appears.

Setting the current time (Manual Adjust) (24-Hour Display)

- 1 Press [MENU].**
Turns on the Menu settings mode and the Menu appears on the display. (☞ page 25 "Menu map")
- 2 Use Δ / ∇ to select "Clock" – "Manual Adjust", then press [ENTER], \blacktriangleleft / \blacktriangleright [ENTER] or \blacktriangleright .**
- 3 Use Δ / ∇ to set the "hours".**
- 4 Press [ENTER], \blacktriangleleft / \blacktriangleright [ENTER] or \blacktriangleright .**
- 5 Use Δ / ∇ to set the "minutes".**
- 6 Press [ENTER], \blacktriangleleft / \blacktriangleright [ENTER] or \blacktriangleright .**
The current time is set.

- Checking the current time when the power is on**
Press [CLOCK].
Press once more and the display returns to its original condition.
- Checking the current time when the power is set to standby**
Press [CLOCK].
The current time is displayed for 30 seconds.

NOTE

The time cannot be set when in the standby mode. Turn on the power first.

Symbols used to indicate buttons in this manual

Button located on both the main unit and the remote control → **BUTTON**
 Button only on the main unit → **<BUTTON>**
 Button only on the remote control → **[BUTTON]**

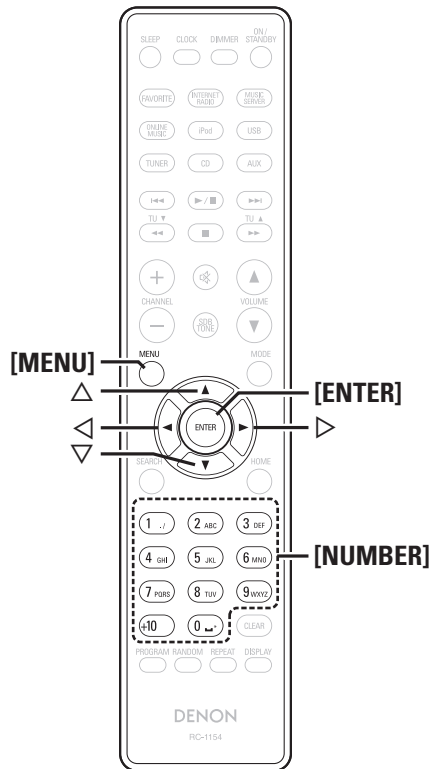
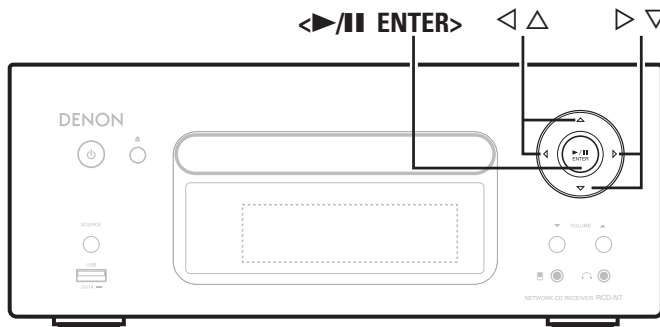

Setting the network [Network]

Connecting Wired LAN

When using this unit with the broadband router's DHCP function enabled, this unit automatically performs the IP address setting and other settings.

When using this unit connected to a network with no DHCP function, make the settings for the IP address, etc., at "Network connecting (DHCP=Off)" (☞ page 28).

NOTE

When setting manually, check the setting contents with the network administrator.

Network connecting

- 1 Connect the LAN cable.**
(☞ page 8 "Connecting to a home network (LAN)")
- 2 Turn on this unit.**
(☞ page 11 "Turning the power on")
- 3 Press [MENU].**
Turns on the Menu settings mode and the Menu appears on the display. (☞ page 25 "Menu map")
- 4 Use Δ / ∇ to select "Network" – "Connection" – "DHCP (Off)", then press [ENTER], \leftarrow /||/ENTER or \triangleright .**
"DHCP" menu appears.
 - When the network connection is set to "DHCP (On)", go to step 6.
- 5 Use Δ / ∇ to select "On", then press [ENTER], \leftarrow /||/ENTER or \triangleright .**
"Connection" menu appears.
- 6 Use Δ / ∇ to select "Connection", then press [ENTER], \leftarrow /||/ENTER or \triangleright .**
The connection starts.
 - When the connection is made successfully, "Succeeded" appears. If the connection fails, "Failed" appears.

NOTE

You may need to set the network connection manually, depending on the provider you use. To set the connection manually, use the setting procedure of "Network connecting (DHCP=Off)".

Network connecting (DHCP=Off)

- 1 Perform steps 1 to 4 of the "Network connecting" procedure and select "Off" in step 5.**
"Connection" menu appears.
- 2 Use Δ / ∇ to select "IP Address", then press [ENTER], \leftarrow /||/ENTER or \triangleright .**
"IP Address" input menu appears.
- 3 Use Δ / ∇ / \triangleright or [NUMBER] (0–9) to input the address and press [ENTER] or \leftarrow /||/ENTER.**
- 4 Use Δ / ∇ / \triangleright or [NUMBER] (0 – 9) to input the address for Subnet Mask, Gateway, Primary DNS, and Secondary DNS.**
- 5 After you input all required addresses, perform step 6 of "Network connecting" to connect to the Internet.**

Proxy Settings

Make this setting when connecting to the Internet via proxy server.

- 1 Press [MENU].**
Turns on the Menu settings mode and the Menu appears on the display. (☞ page 25 “Menu map”)
- 2 Use $\Delta \nabla$ to select “Network” – “Connection” – “Proxy”, then press [ENTER], \blacktriangleleft /|| ENTER or \blacktriangleright .**
“Proxy” setting menu appears.
- 3 If “Proxy(On)” appears, go to step 5. If “Proxy(Off)” appears, press [ENTER], \blacktriangleleft /|| ENTER, or \blacktriangleright .**
“Proxy” (On/Off) setting menu appears.
- 4 Use $\Delta \nabla$ to select “On”, then press [ENTER], \blacktriangleleft /|| ENTER or \blacktriangleright .**
“Proxy” setting menu appears.
- 5 Use $\Delta \nabla$ to select “Proxy (Address)” or “Proxy (Name)”, then press [ENTER], \blacktriangleleft /|| ENTER or \blacktriangleright .**
“Select Type” setting menu appears.
 - Seleccione si Proxy es una dirección de servidor o un nombre de dominio.
- 6 Use $\Delta \nabla$ to select “Address” or “Name”, then press [ENTER], \blacktriangleleft /|| ENTER or \blacktriangleright .**
“Proxy” setting menu appears.
- 7 Use $\Delta \nabla$ to select “Address” or “Name”, then press [ENTER], \blacktriangleleft /|| ENTER or \blacktriangleright .**
“Address” or “Name” input menu appears.
 - Input a server address or domain name.
- 8 Use $\Delta \nabla \triangleright$ or [NUMBER] (0 – 9) to input the address or name, then press [ENTER] or \blacktriangleleft /|| ENTER.**
“Proxy” setting menu appears.
- 9 Use $\Delta \nabla$ to select “Port”, then press [ENTER], \blacktriangleleft /|| ENTER or \blacktriangleright .**
“Port” input menu appears.
- 10 Use $\Delta \nabla \triangleright$ or [NUMBER] (0 – 9) to input the port, then press [ENTER] or \blacktriangleleft /|| ENTER.**
The Proxy settings are completed.

Connecting Wireless LAN

If you cancelled “Network First Setup” or changed the network environment, perform “Menu” – “Network” – “Network First Setup”.

Search Access Point (Wireless LAN)

- 1 Fitting a rod antenna.**
If a LAN cable is connected, remove it.
- 2 Turn on this unit.**
(☞ page 11 “Turning the power on”)
- 3 Press [MENU].**
Turns on the menu settings mode and the menu appears on the display. (☞ page 25 “Menu map”)
- 4 Use $\Delta \nabla$ to select “Network” – “Connection” – “Search Access Point”, then press [ENTER], \blacktriangleleft /|| ENTER or \blacktriangleright .**
The access point you have set is displayed.
- 5 Use $\Delta \nabla$ to select the access point, and then press [ENTER], \blacktriangleleft /|| ENTER or \blacktriangleright .**
If the access point is not detected automatically, use the “Manual Settings” (☞ page 30) procedure.
- 6 If there is an encryption setting for the access point you selected in step 5, enter same encryption key as used for the access point. (If there is no encryption setting, proceed to step 7.)**
Use $\Delta \nabla \triangleleft \triangleright$ to input the “Key” (encryption key) and press [ENTER], \blacktriangleleft /|| ENTER or \blacktriangleright . Enter the same encryption key as used for the access point.
 - The types of characters that can be input are as shown below.

[Upper case characters]
ABCDEFGHIJKLMNOPQRSTUVWXYZ

[Lower case characters]
abcdefghijklmnopqrstuvwxyz

[Symbols] ! " # \$ % & ' () * + , - . / : ; < = > ? @ [\] ^ _ ` { | } ~

[Numbers] 0123456789 (Space)

 - When no security settings have been used in the Internet connection settings, this step is not necessary.

- 7 Use ∇ to select “Connection”, then press [ENTER], \blacktriangleleft /|| ENTER or \blacktriangleright .**
Network connection starts.

- This unit performs automatic network setup due to the DHCP function.
- When connecting to a network that has no DHCP function, perform the setting in Network connecting (DHCP=Off) (☞ page 28).

WPS Settings (Push-button method)

- 1 Press [MENU].**
Turns on the Menu settings mode and the Menu appears on the display. (☞ page 25 “Menu map”)
- 2 Use $\Delta \nabla$ to select “Network” – “Connection” – “WPS” – “Push Button”, then press [ENTER], \blacktriangleleft /|| ENTER or \blacktriangleright .**
- 3 Use $\Delta \nabla$ to select “Enter”, then press [ENTER], \blacktriangleleft /|| ENTER or \blacktriangleright .**
Please push the WPS button of the router, and push the Enter button of the machine.
- 4 When connection is established with access point, “Succeeded” is displayed.**

WPS Settings (PIN code method)

- 1 Press [MENU].**
Turns on the Menu settings mode and the Menu appears on the display. (☞ page 25 “Menu map”)
- 2 Use $\Delta \nabla$ to select “Network” – “Connection” – “WPS” – “PIN code”, then press [ENTER], \blacktriangleleft /|| ENTER or \blacktriangleright .**
The access point you have set is displayed.
- 3 Use $\Delta \nabla$ to select the access point, then press [ENTER], \blacktriangleleft /|| ENTER, or \blacktriangleright .**
PIN code number is displayed.
- 4 Set this PIN code to the register.**
When connection is established with access point, “Succeeded” is displayed.

Symbols used to indicate buttons in this manual

Button located on both the main unit and the remote control → **BUTTON**
 Button only on the main unit → **<BUTTON>**
 Button only on the remote control → **[BUTTON]**

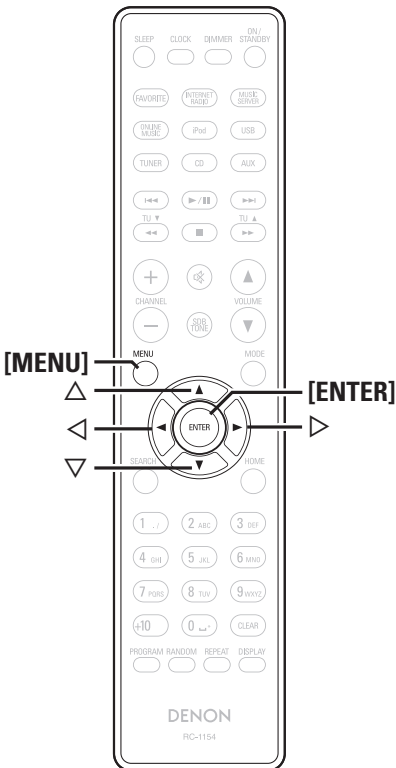
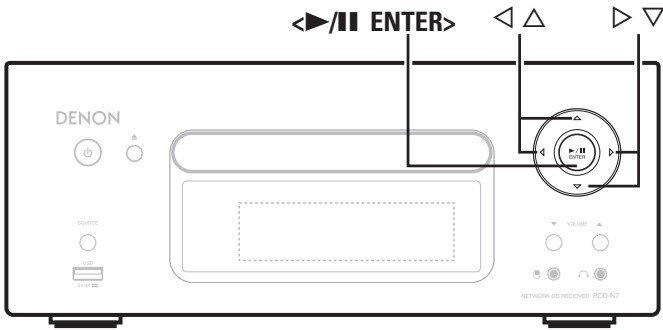

Manual Settings

- 1** Press **[MENU]**.
Turns on the Menu settings mode and the Menu appears on the display. (☞ page 25 "Menu map")
- 2** Use $\Delta \nabla$ to select "Network" – "Connection" – "Manual setting", then press **[ENTER]**, **<▶/|| ENTER>** or **▷**.
- 3** Use $\Delta \nabla$ to select "SSID", then press **[ENTER]**, **<▶/|| ENTER>** or **▷**.
- 4** Use $\Delta \nabla \triangleleft \triangleright$ to input the name of the wireless network (SSID), then press **[ENTER]** or **<▶/|| ENTER>**.

• The types of characters that can be input are as shown below.

[Upper case characters]
 ABCDEFGHIJKLMNOPQRSTUVWXYZ
[Lower case characters]
 abcdefghijklmnopqrstuvwxyz
[Symbols] ! " # \$ % & ' () * + , - . / : ; < = > ? @ [\] ^ _ ` { | } ~
[Numbers] 0123456789 (Space)

- 5** Use $\Delta \nabla$ to select "Security", then press **[ENTER]**, **<▶/|| ENTER>** or **▷**.
- 6** Use $\Delta \nabla$ to select following items, then press **[ENTER]**, **<▶/|| ENTER>** or **▷**.

- **None** : Select if not encrypted. Can also be used even without encryption, through we recommend encryption for improved security.
- **WEP / WPA(TKIP) / WPA(AES) / WPA2(TKIP) / WPA2(AES)** : Select the encryption method according to the encryption setting of the access point you are using.

- 7** Use $\Delta \nabla$ to input the "Key" (encryption key), then press **[ENTER]** or **<▶/|| ENTER>**.

- Enter the same encryption key as used for the access point.
- When no security settings have been used in the Internet connection settings, this step is not necessary.
- When connecting to a "WEP" encrypted network, set the access point "Default Key" to "1".

- 8** Use ∇ to select "Connection" and press **[ENTER]**, **<▶/|| ENTER>** or **▷**.

- Network connection starts.
- This unit performs automatic network setup due to the DHCP function.

Last.fm Display

Set whether or not to display Last.fm item on the menu.

- 1** Press **[MENU]**.
Turns on the Menu settings mode and the Menu appears on the display. (☞ page 25 "Menu map")
- 2** Use $\Delta \nabla$ to select "Network" – "Last.fm Display", then press **[ENTER]**, **<▶/|| ENTER>** or **▷**.
"Last.fm Display" appears.
- 3** Use $\Delta \nabla$ to select "Display" or "Hidden", then press **[ENTER]**, **<▶/|| ENTER>** or **▷**.

- Display** : Last.fm items will be displayed.
- Hidden** : Last.fm items will not be displayed.

Party Mode Function

The same network audio (Internet radio, music server or iPod DIRECT) can be played on multiple DENON products equipped with the Party Mode function and connected in a network.

The party mode consists of one organizer and up to four attendees.

When one unit starts the party mode as the organizer, up to four devices on which the party mode function is activated automatically participate in the party as attendees. "Party Mode Function" must be set to "ON" ahead of time in order to use the party mode function.

□ Setting the Party Mode Function

1 Press [MENU].
Turns on the Menu settings mode and the Menu appears on the display. (☞ page 25 "Menu map")

2 Use Δ / ∇ to select "Network" – "Party Mode" – "Party Mode Function", then press [ENTER], \blacktriangleleft / \blacktriangleright /|| ENTER> or \blacktriangleright .
"P-Mode Function" menu appears.

3 Use Δ / ∇ to select "On" or "Off", then press [ENTER], \blacktriangleleft / \blacktriangleright /|| ENTER> or \blacktriangleright .

On : Enable party mode function.

Off : Disable party mode function.

□ Starting the party mode as the organizer

1 Press [MENU].
Turns on the Menu settings mode and the Menu appears on the display. (☞ page 25 "Menu map")

2 Use Δ / ∇ to select "Network" – "Party Mode" – "Start Party", then press [ENTER], \blacktriangleleft / \blacktriangleright /|| ENTER> or \blacktriangleright .

- An error message is displayed when you are not connected to a network.
- The input source automatically switches to "Internet Radio" and the attendees are automatically selected.

3 Play the desired station.

Canceling the party mode

1 Press [MENU].
Turns on the Menu settings mode and the Menu appears on the display. (☞ page 25 "Menu map")

2 Use Δ / ∇ to select "Network" – "Party Mode" – "Stop Party", then press [ENTER], \blacktriangleleft / \blacktriangleright /|| ENTER> or \blacktriangleright .
"Exit Party Mode?" is displayed on the menu screen.

3 Use Δ / ∇ to select "Yes", then press [ENTER], \blacktriangleleft / \blacktriangleright /|| ENTER> or \blacktriangleright .
"Attendees P.Off?" is displayed.

4 Use Δ / ∇ to select "Yes" or "No", then press [ENTER], \blacktriangleleft / \blacktriangleright /|| ENTER> or \blacktriangleright .

Yes : The power of the attendees is turned off and the party mode is canceled.

No : The party mode is canceled without turning off the power of the attendees.

□ Participating in the party mode as an attendee

- When the organizer starts the party mode, up to four attendees are selected automatically. No operation is required.
- When a device becomes an attendee, **Party Mode Attendee** appears on the display. The input source automatically switches to "Internet Radio" and the same network audio as on the organizer is played.
- If there are fewer than four attendees, a device can join the party mode after it has started. To participate in the party mode, perform the operation described below.

1 Press [MENU].
Turns on the Menu settings mode and the Menu appears on the display. (☞ page 25 "Menu map")

2 Use Δ / ∇ to select "Network" – "Party Mode" – "Start Party", then press [ENTER], \blacktriangleleft / \blacktriangleright /|| ENTER> or \blacktriangleright .

- An error message is displayed when you are not connected to a network.

Canceling the party mode

1 Press [MENU].
Turns on the Menu settings mode and the Menu appears on the display. (☞ page 25 "Menu map")

2 Use Δ / ∇ to select "Network" – "Party Mode" – "Stop Party", then press [ENTER], \blacktriangleleft / \blacktriangleright /|| ENTER> or \blacktriangleright .
"Exit Party Mode?" is displayed on the menu screen.

3 Use Δ / ∇ to select "Yes", then press [ENTER], \blacktriangleleft / \blacktriangleright /|| ENTER> or \blacktriangleright .
In this case, the other devices remain in the party mode.



"Last.fm", "Napster" and "USB" are not available in the Party Mode. There can only be one organizer in the network. To form a new party mode, first cancel the current party mode.

□ Setting the Party Start Level

Make settings for volume level when the party mode is started.

1 Press [MENU].
Turns on the Menu settings mode and the Menu appears on the display. (☞ page 25 "Menu map")

2 Use Δ / ∇ to select "Network" – "Party Mode" – "Party Start Level", then press [ENTER], \blacktriangleleft / \blacktriangleright /|| ENTER> or \blacktriangleright .

- **Last** : The same volume as set before the party mode was started.
- **00** : Always use the muting on condition when the party mode is started.
- **01 – 60dB** : Start party mode with your preferred volume.



This can be set when "Party Mode Function" is set to "ON".

Symbols used to indicate buttons in this manual

Button located on both the main unit and the remote control → **BUTTON**
 Button only on the main unit → **<BUTTON>**
 Button only on the remote control → **[BUTTON]**

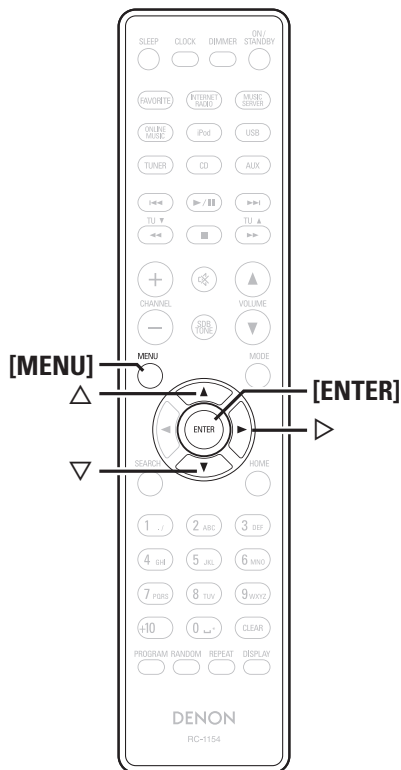
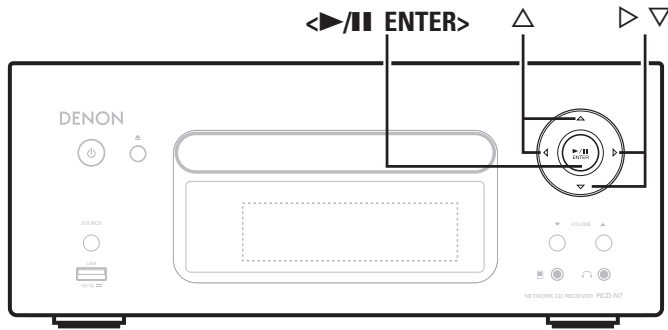

Other Network

Network Standby

Set the network function On/Off during standby.

- 1 Press [MENU].**
Turns on the Menu settings mode and the Menu appears on the display. (☞ page 25 “Menu map”)
- 2 Use Δ / ∇ to select “Network” – “Other Network” – “Network Standby”, then press [ENTER], \blacktriangleleft / \blacktriangleright [ENTER] or \blacktriangleright .**
“Network Standby” menu appears.
- 3 Use Δ / ∇ to “On”, then press [ENTER], \blacktriangleleft / \blacktriangleright [ENTER] or \blacktriangleright .**

- On** : Shortens the time before the network connection is completed.
- Power consumption during the standby mode will be higher. (Power consumption: 3 W)
 - Network standby mode is set and the power indicator lights red.
- Off** : Power consumption during the standby mode will be minimized. (Power consumption: 0.3 W)
- It will take slightly longer till the network connection is completed.
 - This is the default setting.

PC Language

Select computer environment language.

- 1 Press [MENU].**
Turns on the Menu settings mode and the Menu appears on the display. (☞ page 25 “Menu map”)
- 2 Use Δ / ∇ to select “Network” – “Other Network” – “PC Language”, then press [ENTER], \blacktriangleleft / \blacktriangleright [ENTER] or \blacktriangleright .**
“PC Language” setting menu appears.
- 3 Use Δ / ∇ to select your computer environment language, then press [ENTER], \blacktriangleleft / \blacktriangleright [ENTER] or \blacktriangleright .**

Friendly Name Edit

The Friendly Name is the name of this unit displayed on the network.

- 1 Press [MENU].**
Turns on the Menu settings mode and the Menu appears on the display. (☞ page 25 “Menu map”)
- 2 Use Δ / ∇ to select “Network” – “Other Network” – “Friendly Name Edit”, then press [ENTER], \blacktriangleleft / \blacktriangleright [ENTER] or \blacktriangleright .**
“Friendly Name Edit” menu appears.
- 3 Edit a friendly name.**
For the character input method, see “Inputting characters” (☞ page 34)

Network Status

Displays up to a maximum of 10 DENON products connected on the same network.

- **Friendly Name / Party Mode Status / Model Name / Power ON / Standby / Select Source / Volume Level**

Setting the others [Other]

Auto Standby

With the Auto standby ON, this unit will automatically enter the standby mode after about 30 continuous minutes of stop mode with no operation.

- The default setting is "OFF".

1 Press [MENU].

Turns on the Menu settings mode and the Menu appears on the display. (☞ page 25 "Menu map")

2 Use Δ / ∇ to select "Other" – "Auto Standby", then press [ENTER], \blacktriangleleft /||/ENTER or \blacktriangleright .

3 Use Δ / ∇ to select "On", then press [ENTER], \blacktriangleleft /||/ENTER or \blacktriangleright .

The setting is entered.

NOTE

In the following situations, the Auto standby function does not operate.

- During CD playback or pause.
- When an iPod or USB memory device is connected to the USB port on the unit. When an iPod is connected to the iPod dock on the unit.
- When the input source is "TUNER", "AUX1", "AUX2" or "AUX3".
- When the input source is "Portable In" and a device connected to the Portable In jack.
- When the input source is "AUX3" and a signal is input.
- When the input source is "INTERNET RADIO", "MUSIC SERVER" or "ONLINE MUSIC", and an ethernet cable is connected to NETWORK connector.

Screen Saver

Use the following procedure to set the screen saver.

1 Press [MENU].

Turns on the Menu settings mode and the Menu appears on the display. (☞ page 25 "Menu map")

2 Use Δ / ∇ to select "Other" – "Screen Saver", then press [ENTER], \blacktriangleleft /||/ENTER or \blacktriangleright .

"Screen Saver" menu appears.

3 Use Δ / ∇ to select "ON", then press [ENTER], \blacktriangleleft /||/ENTER or \blacktriangleright .

Using an optimizing filter

An optimizing filter suited for the properties of the speakers (SC-N7) can be used.

1 Press [MENU].

Turns on the Menu settings mode and the Menu appears on the display. (☞ page 25 "Menu map")

2 Use Δ / ∇ to select "Other" – "Speaker Optimize", then press [ENTER], \blacktriangleleft /||/ENTER or \blacktriangleright .

"Speaker Optimize" menu appears.

3 Use Δ / ∇ to select "ON", then press [ENTER], \blacktriangleleft /||/ENTER or \blacktriangleright .

ON : The response is optimized for the speakers (SC-N7, sold separately).

OFF : The response is flat.

Firmware Update

- In order to use these functions, you must have the correct system requirements and settings for a broadband Internet connection (☞ page 8).
- Perform the firmware update operation after at least 2 minutes has elapsed since turning this unit's power ON.

1 Press [MENU].

Turns on the Menu settings mode and the Menu appears on the display. (☞ page 25 "Menu map")

2 Use Δ / ∇ to select "Other" – "Firmware Update", then press [ENTER], \blacktriangleleft /||/ENTER or \blacktriangleright .

[Selectable items]

Check for Update : Check for firmware updates. You can also check approximately how long it will take to complete an update.

Start : Execute the update process.

- If updating fails, the set automatically retries, but if updating is still not possible, one of the messages shown below is displayed. If the display reads as shown below, check the settings and network environment, then update again.

Display	Description
Updating fail	Updating failed.
Login failed	Failure to log into server.
Server is busy	Server is busy. Wait a while then try again.
Connection fail	Failure in connecting to server.
Download fail	Downloading of the firmware has failed.

[Notes concerning use of "Firmware Update"]

- Do not turn off the power until updating is completed.
- Even with a broadband connection to the Internet, approximately 20 minutes is required for the updating procedure to be completed.
- Once updating starts, normal operations on this unit cannot be performed until updating is completed.
- Furthermore, updating the firmware may reset the backup data for the parameters, etc. set for this unit.
- If the update fails, remove and re-insert the power cord. "Update retry" appears on the display and update restarts from the point at which update failed. If the error continues despite this, check the network environment.

Symbols used to indicate buttons in this manual

- Button located on both the main unit and the remote control → **BUTTON**
- Button only on the main unit → **<BUTTON>**
- Button only on the remote control → **[BUTTON]**

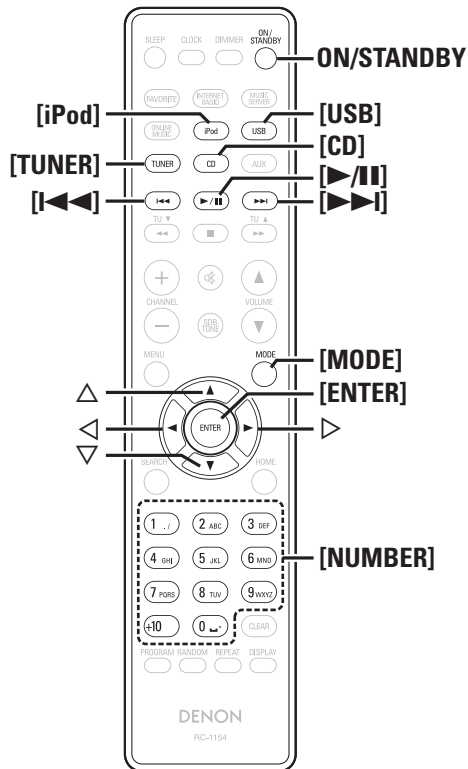
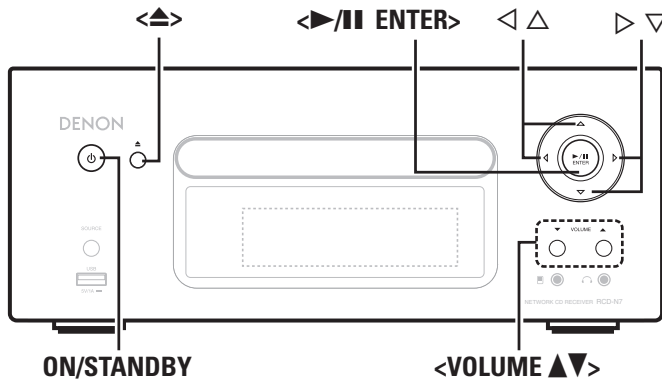

Other functions

Inputting characters

You can change the names as desired using the "Preset Name" (page 16), "Napster Account" (page 22), "Last.fm account" (page 21) and character input for the network functions.

For inputting characters, there are two methods, as shown below.

Method	Operations
Using the number buttons	<ul style="list-style-type: none"> Operating with the remote control unit. Multiple characters are assigned to a button, and each time the button is pressed, a character is switched.
Using the cursor buttons	<ul style="list-style-type: none"> Operating with the remote control unit or the main unit. Use ▲▼◀▶ and [ENTER] or ◀▶/ ENTER> to input characters.

Display of an input screen

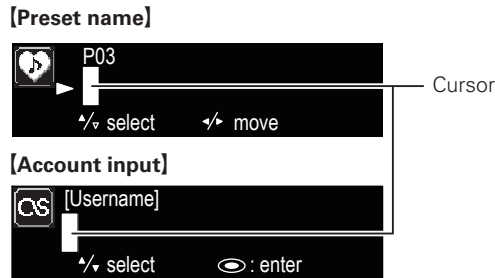

Using the number buttons

1 Display the screen for inputting characters.

2 Place the cursor at the character to be changed with ◀▶ and press [NUMBER] (0 – 9) until the desired character is displayed.

The types of characters that can be input are as shown below.

1 . /	1 . @ - _ / : ~	6 MNO	m n o M N O 6
2 ABC	a b c A B C 2	7 PQRS	p q r s P Q R S 7
3 DEF	d e f D E F 3	8 TUV	t u v T U V 8
4 GHI	g h i G H I 4	9 WXYZ	w x y z W X Y Z 9
5 JKL	j k l J K L 5	0 - +	0 (Space) ! " # \$ % & ' () * + , ; < = > ? [\] ^ ` { }

- The input character type can be switched by pressing [MODE] while the display name is being changed.
- For entering the characters assigned to one number button continuously, press ▶ to move the cursor to the right after entering a character then enter the next character.
- For entering characters assigned to separate buttons, press the number button continuously. The cursor automatically moves to the next position, and the entered character is registered.

3 Repeat step 2 to change the name then press [ENTER] or ◀▶/|| ENTER> to register it.

Example: For changing characters from "POPS" to "ROCK"

- Place the cursor at "P". ▶ POPS
- Press ^{PQRS}7 seven times. ▶ ROPS
"P" changes to "R".
- Press ▶ twice. ▶ ROPS
"R" is automatically registered, and the cursor placed "P".
- Press ^{ABC}2 six times. ▶ ROC S
"P" changes to "C".
- Press ▶. ▶ ROC S
"C" is registered and the cursor placed "S".
- Press ^{JKL}5 five times. ▶ ROCK
"S" changes to "K".
- Press [ENTER] or ◀▶/|| ENTER> to register the input name.

Using the cursor buttons

1 Display the screen for inputting characters.

2 Use ◀ ▶ to set the cursor to the character you want to change.

3 Use △ ▽ to change the character.

- The types of characters that can be input are as shown below.

<p>[Upper case characters] ABCDEFGHIJKLMNOPQRSTUVWXYZ</p> <p>[Lower case characters] abcdefghijklmnopqrstuvwxyz</p> <p>[Symbols] ! " # \$ % & ' () * + , - . / : ; < = > ? @ [\] ^ _ ` { } ~</p> <p>[Numbers] 0123456789 (Space)</p>
--

- The input character type can be switched by pressing [MODE] while the display name is being changed.

Other buttons

- Press [◀◀] to delete the character.
- Press [▶▶] to insert a space.

4 Repeat steps 2 and 3 to change the name then press [ENTER] or ◀▶/|| ENTER> to register it.

Auto power on

When the power is in standby, the power turns on when any of the buttons below other than **ON/STANDBY** is operated, and the respective operation is performed.

- <▲>..... The disc tray opens.
- [▶/||]..... Playback of the "CD", "iPod" or "USB" starts.
- [TUNER]..... Playback of the tuner starts.
- [CD]..... The input source switches to "CD" and the disc starts playing.
- [iPod]..... The input source switches to "iPod" and the iPod starts playing.
- [USB]..... The input source switches to "USB" and the USB starts playing.

Last function memory

This stores the settings as they were immediately before going into the standby mode.

When the power is turned back on, the settings are restored to as they were immediately before going into the standby mode.

Resetting the microprocessor

Perform this procedure if the display is abnormal or if operations cannot be performed.

When the microprocessor is reset, all the settings are reset to their default values.

1 Unplug the power cord.

2 Plug the power cord into a power outlet while pressing <VOLUME ▲> and <VOLUME ▼> simultaneously.
 "Initialized" is displayed.



If "Initialized" does not display in step 2, start over from step 1.

Information

Part names and functions

For buttons not explained here, see the page indicated in parentheses ().

Front panel

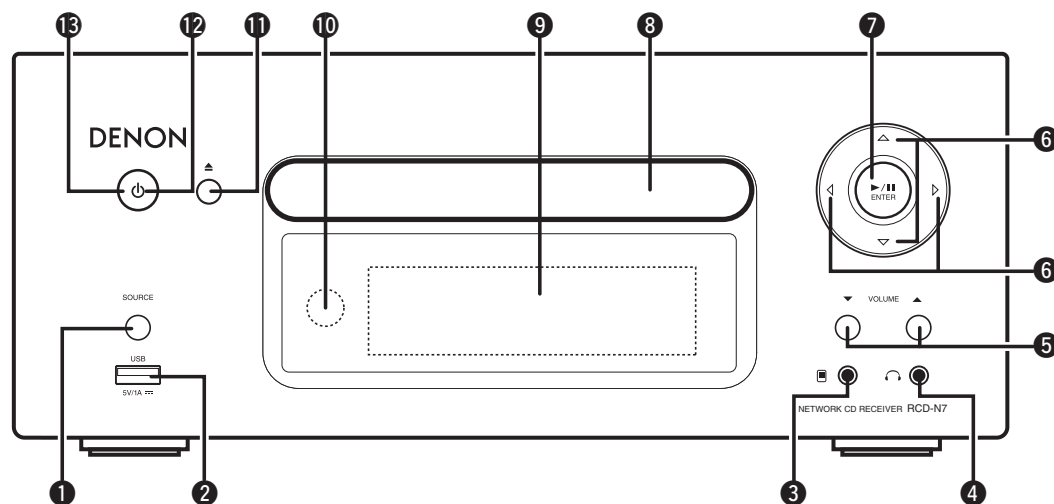

- | | |
|---|---|
| <p>1 SOURCE button (12)
Selects the input source.</p> <p>2 USB port (9)
Used to connect iPod or USB memory devices.</p> <p>3 Portable in jack () (23)
Used to connect portable audio devices.</p> <p>4 Headphones jack () (13)
Used to connect headphones.</p> <p>5 Volume up/down button (VOLUME ▲▼) (12)
Adjusts the audio volume.</p> <p>6 Cursor button (▲▼◀▶) (12)</p> | <p>7 Play/Pause/ENTER button (▶/ /ENTER) (13)</p> <p>8 Disc tray (3)
Tray used to insert a compact disc.</p> <p>9 Display
Displays play status, settings, etc.</p> <p>10 Remote control sensor (4)</p> <p>11 Disc tray open/close button (▲) (13)
Used to open/close the disc tray.</p> <p>12 Power indicator (11)</p> <p>13 Power operation button (ON/STANDBY) (11)</p> |
|---|---|

Top panel

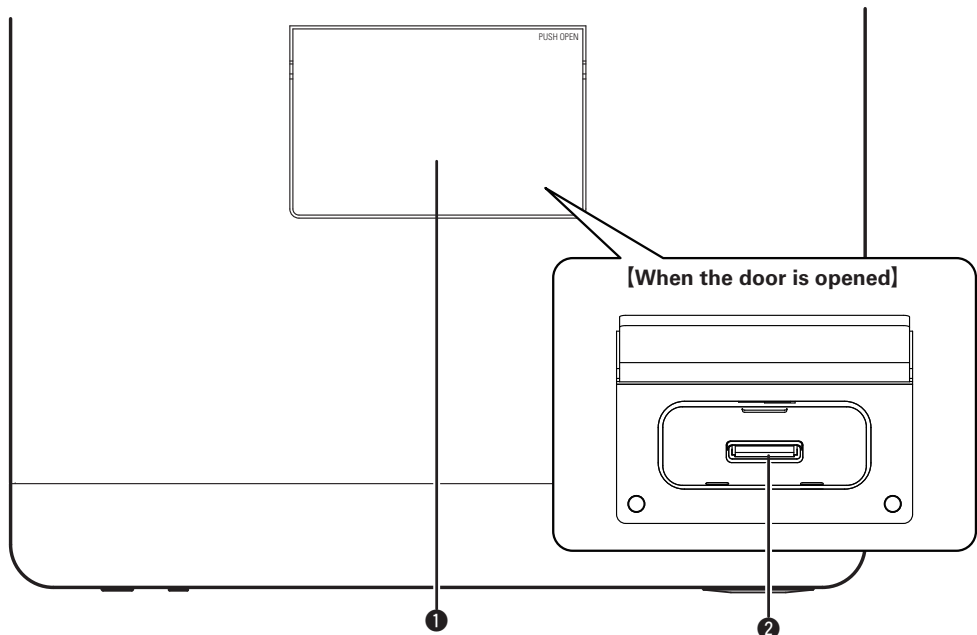

- 1 Dock for iPod (9)
- 2 Dock connector..... (9)

Rear panel

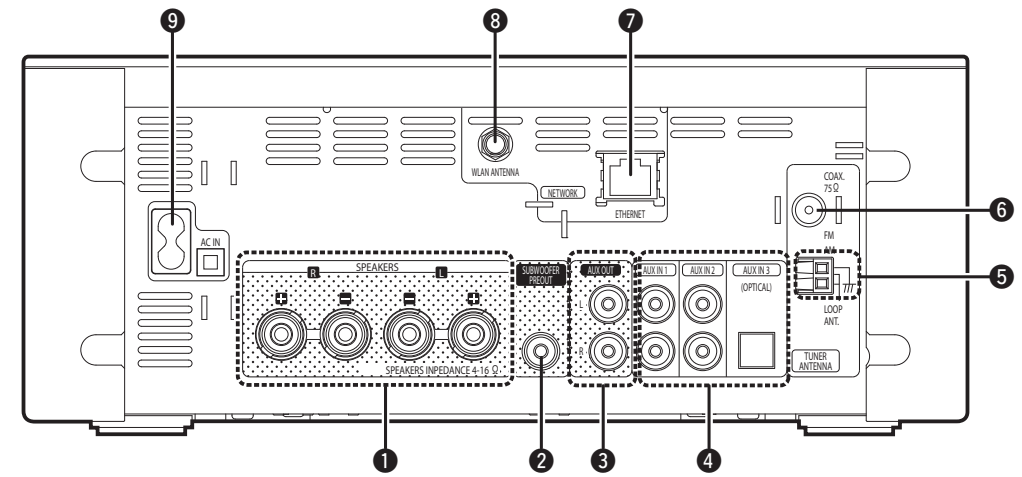

- 1 Speaker output terminals..... (5)
Connect to the speakers.
- 2 SUBWOOFER PRE OUT terminal..... (5)
Connect to the input terminal of a powered subwoofer.
- 3 AUX OUT terminals (6)
Connect to an external pre-main amplifier.
- 4 AUX IN terminals (6)
Connect to analog/digital audio.
- 5 AM antenna terminal (7)
Connect to the supplied AM antenna.
- 6 FM antenna terminal..... (7)
Connect the supplied FM antenna. Connect to an external antenna if reception is poor.
- 7 ETHERNET connector (8)
- 8 WLAN ANTENNA terminal (8)
- 9 AC inlet (AC IN)..... (10)
Connect the supplied AC power cord.

Getting Started

Connections

Basic Operations

Advanced Operations

Information

Explanation terms

Troubleshooting

Specifications

Index

Remote control

This section explains the buttons used to playback each input source.

Buttons that work with all input sources (CD, TUNER, iPod, USB and NETWORK)

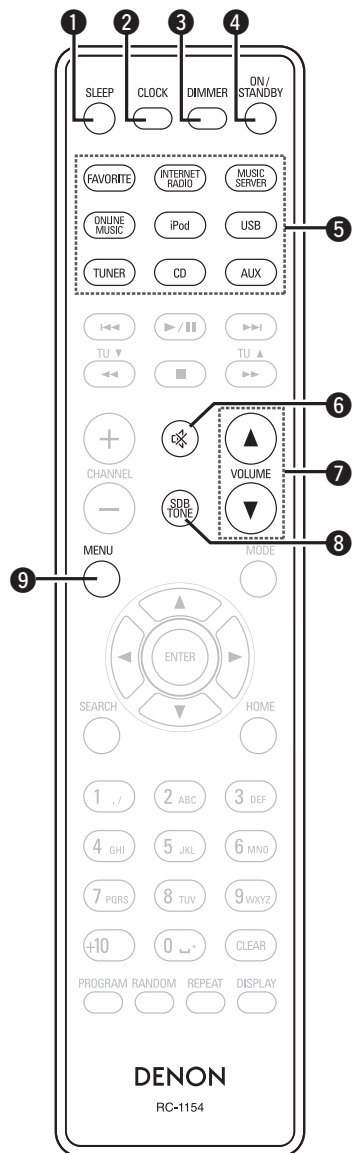

- 1 SLEEP button (13)
- 2 CLOCK button (27)
- 3 DIMMER button (13)
- 4 ON/STANDBY button (11)
- 5 Input source select button (12)
- 6 MUTE button (12)
- 7 Master volume control buttons (VOLUME) (12)
- 8 SDB/TONE button (12)
- 9 MENU button (26 – 33)

Buttons that work with CDs

The buttons listed at “Buttons that work with all input sources” can also be used.

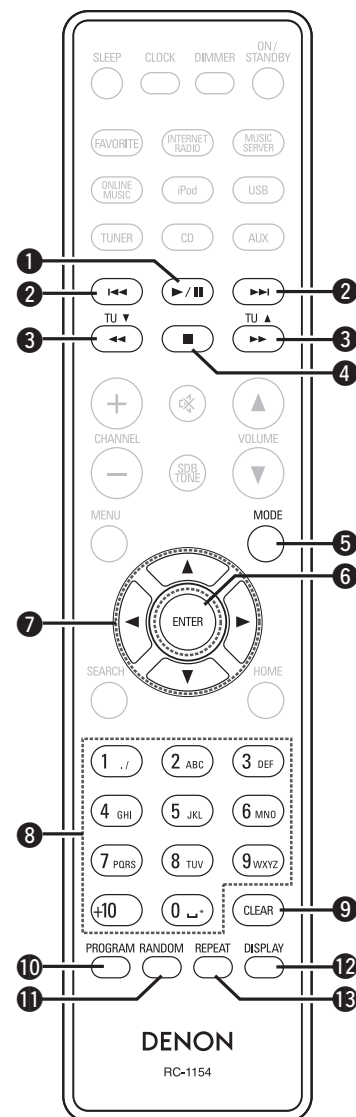

- 1 Play/Pause button (▶/⏸) (13)
- 2 Reverse-skip/Forward-skip buttons (◀◀, ▶▶) (13)
- 3 Fast-reverse/Fast-forward buttons (◀◀, ▶▶) (13)
- 4 Stop button (■) (13)
- 5 MODE button (15)
- 6 ENTER button (13)
- 7 Cursor buttons (▲▼◀▶) (15)
- 8 Number buttons (13)
- 9 CLEAR button (14)
- 10 PROGRAM button (14)
- 11 RANDOM button (14)
- 12 DISPLAY button (13)
- 13 REPEAT button (14)

Buttons that work with the tuner

The buttons listed at "Buttons that work with all input sources" can also be used.

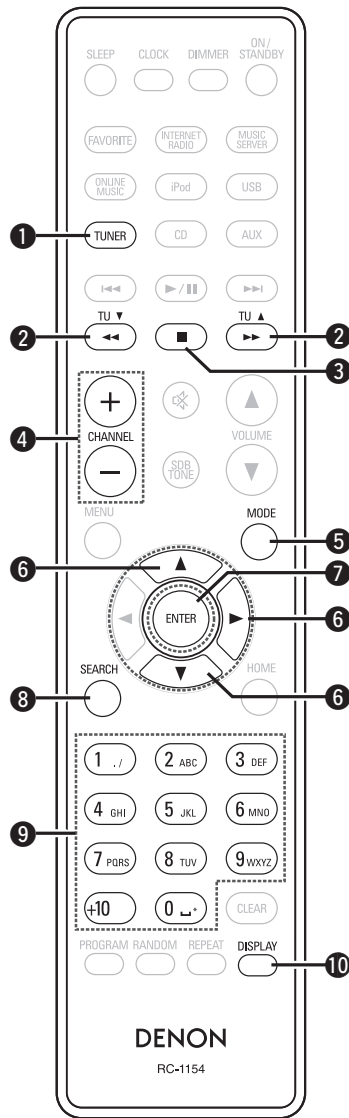

- 1 **TUNER button** (16)
- 2 **TUNING buttons (TU ▲, TU ▼)** (16)
- 3 **Stop button (■)** (16)
- 4 **Channel buttons (+, -)** (17)
- 5 **MODE button** (16)
- 6 **Cursor buttons (▲▼▷)** (16)
- 7 **ENTER button** (16)
- 8 **SEARCH button** (16)
- 9 **Number buttons** (17)
- 10 **DISPLAY button** (24)

Buttons that work with iPods or USBs

The buttons listed at "Buttons that work with all input sources" can also be used.

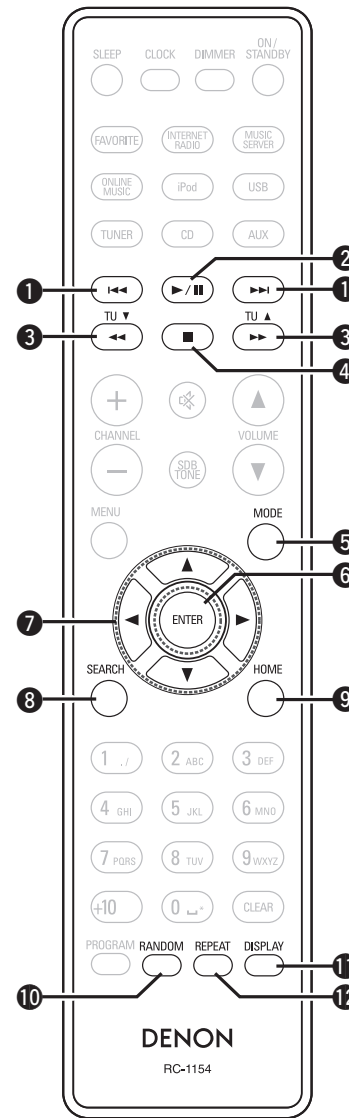

- 1 **Reverse-skip/Forward-skip buttons (◀◀, ▶▶)** (18)
- 2 **Play/Pause button (▶/||)** (17)
- 3 **Fast-reverse/Fast-forward buttons (◀◀, ▶▶)** (18)
- 4 **Stop button (■)** (18)
- 5 **MODE button** (17)
- 6 **ENTER button** (17)
- 7 **Cursor buttons (▲▼◀▷)** (17)
- 8 **SEARCH button** (19)
- 9 **HOME button** (18)
- 10 **RANDOM button** (18)
- 11 **DISPLAY button** (18)
- 12 **REPEAT button** (18)

Getting Started

Connections

Basic Operations

Advanced Operations

Information

Explanation terms

Troubleshooting

Specifications

Index

Buttons that work with Network

The buttons listed at "Buttons that work with all input sources" can also be used.

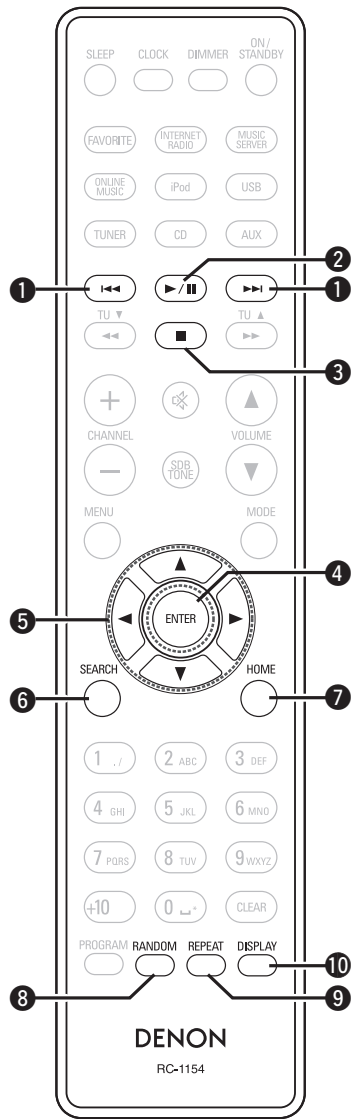

- 1 Reverse-skip/Forward-skip buttons**
(|◀◀, ▶▶|) (21)
- 2 Play/Pause button (▶/||)** (21)
- 3 Stop button (■)** (20)
- 4 ENTER button** (19)
- 5 Cursor buttons (△▽◀▶)** (19)
- 6 SEARCH button** (20)
- 7 HOME button** (20)
- 8 RANDOM button** (21)
- 9 REPEAT button** (21)
- 10 DISPLAY button** (19)

MP3 and WMA

MP3 and WMA formats

CD-R and CD-RW discs created in the format described below can be played.

❑ Writing software format

ISO9660 level 1

When written in other formats, it may not be possible to play the disc properly.

❑ Maximum number of playable files and folders

Total number of folders and files : 512

Number of folders : 256

❑ File format

MPEG-1 Audio Layer-3

WMA (Windows Media Audio)

❑ Tag data

ID3-Tag (Ver. 1.x and 2.x)

META-Tag

(Compatible with title, artist and album names)

Playable MP3/WMA file			
File format	Sampling frequency	Bit rate	Extension
MP3	32, 44.1, 48 kHz	32 ~ 320 kbps	.mp3
WMA	32, 44.1, 48 kHz	64 ~ 192 kbps	.wma



- Be sure to give files the extension “.MP3” or “.WMA”. Files with any other extensions or with no extensions cannot be played.
- Mac OS X files assigned with filenames that begin with “.” are not music data and cannot be played back.
- In accordance with copyright laws, recordings you have made should only be used for your personal enjoyment and may not be used in other ways without permission of the copyright holder.

iPod®



“Made for iPod” and “Made for iPhone” mean that an electronic accessory has been designed to connect specifically to iPod, or iPhone, respectively, and has been certified by the developer to meet Apple performance standards.

Apple is not responsible for the operation of this device or its compliance with safety and regulatory standards.

Please note that the use of this accessory with iPod or iPhone may affect wireless performance.

iPhone, iPod, iPod classic, iPod nano, iPod shuffle, and iPod touch are trademarks of Apple Inc., registered in the U.S. and other countries.

- Individual users are permitted to use iPhone, iPod, iPod classic, iPod nano, iPod shuffle, and iPod touch for private copy and playback of non-copyrighted contents and contents whose copy and playback is permitted by law. Copyright infringement is prohibited by law.

NOTE

- DENON will accept no responsibility whatsoever for any loss of iPod data.
- Depending on the type of iPod and the software version, some functions may not operate.
- When connecting an iPhone to the USB port of this unit, keep the iPhone at least 20cm away from this unit. If the iPhone is kept closer to this unit and a telephone call is received by the iPhone, noise may be output from this device.

USB memory device

Important information

A USB memory device can be connected to the USB port of this unit to play music files stored on the USB memory device.

Also, files stored on an iPod can be played when the iPod is connected directly to the USB port of this unit. See "Connecting an iPod" (page 9).

- Only USB memory devices conforming to mass storage class and MTP (Media Transfer Protocol) standards can be played on this unit.
- This unit is compatible with USB memory devices in "FAT16" or "FAT32" format.



If the number of files stored in a USB memory device exceeds 1,000, the access speed may become slower.

[Compatible formats]

	USB memory devices *1
WMA (Windows Media Audio)	✓ *2
MP3 (MPEG-1 Audio Layer-3)	✓
WAV	✓
MPEG-4 AAC	✓ *3
FLAC (Free Lossless Audio Codec)	✓

*1 USB

- This unit is compatible with MP3 ID3-Tag (Ver. 2) standard.
- This unit is compatible with WMA META tags.
- WAV format Quantization bit rate: 16 bits.

*2 Copyright-protected files can be played on certain portable players compatible with MTP.

*3 Only files that are not protected by copyright can be played on this unit.

Content downloaded from pay sites on the Internet are copyright protected. Also, files encoded in WMA format when ripped from a CD, etc. on a computer may be copyright protected, depending on the computer's settings.

[Compatible formats]

	Sampling frequency	Bit rate	Extension
WMA (Windows Media Audio)	32/44.1/48 kHz	48 – 192 kbps	.wma
MP3 (MPEG-1 Audio Layer-3)	32/44.1/48 kHz	32 – 320 kbps	.mp3
WAV	32/44.1/48 kHz	–	.wav
MPEG-4 AAC	32/44.1/48 kHz	16 – 320 kbps	.aac/ .m4a/ .mp4
FLAC (Free Lossless Audio Codec)	32/44.1/48/96 kHz	–	.flac

Network audio

Important information

❑ About the internet radio function

- Internet radio refers to radio broadcasts distributed over the Internet.
Internet radio stations from around the world can be received.
- This unit is equipped with the following Internet radio functions:
 - Stations can be selected by genre and region.
 - Up to 56 Internet radio stations can be preset.
 - Internet radio stations in MP3 and WMA (Windows Media Audio) format can be listened to.
 - Your favorite radio stations can be registered by accessing an exclusive DENON Internet radio URL from a Web browser on a computer.
- The function is managed for individual users, so you must provide your MAC or e-mail address.
Exclusive URL: <http://www.radiodenon.com>
- The radio station database service may be suspended without notice.
- This unit's Internet radio station list is created using a radio station database service (vTuner). This database service provides a list edited and created for this unit.

❑ Music server

This function lets you play music files and playlists (m3u, wpl) stored on a computer (music server) connected to this unit via a network.

With this unit's network audio playback function, connection to the server is possible using one of the technologies below.

- Windows Media Player Network Sharing Service
- Windows Media DRM10

[Compatible formats]

	Internet radio	Music server *1
WMA (Windows Media Audio)	✓	✓
MP3 (MPEG-1 Audio Layer-3)	✓	✓
WAV		✓
MPEG-4 AAC		✓*2
FLAC (Free Lossless Audio Codec)		✓

A server or server software compatible with distribution in the corresponding formats is required to play music files via a network.

*1 Music server

- This unit is compatible with MP3 ID3-Tag (Ver. 2) standard.
- This unit is compatible with WMA META tags.
- WAV format Quantization bit rate: 16 bits.

*2 Only files that are not protected by copyright can be played on this unit.

Content downloaded from pay sites on the Internet are copyright protected. Also, files encoded in WMA format when ripped from a CD, etc. on a computer may be copyright protected, depending on the computer's settings.

[Compatible formats]

	Sampling frequency	Bit rate	Extension
WMA (Windows Media Audio)	32/44.1/48 kHz	48 – 192 kbps	.wma
MP3 (MPEG-1 Audio Layer-3)	32/44.1/48 kHz	32 – 320 kbps	.mp3
WAV	32/44.1/48 kHz	–	.wav
MPEG-4 AAC	32/44.1/48 kHz	16 – 320 kbps	.aac/ .m4a/ .mp4
FLAC (Free Lossless Audio Codec)	32/44.1/48/96 kHz	–	.flac

❑ About Napster

Napster is a monthly subscription music distribution service provided by Napster LLC. This service allows users to download and play pieces of music they want to hear on this unit. Before you can use Napster, you will need to visit the Napster website on your PC to create an account and register as a member. For details, access the following site:

http://www.napster.com/choose/index_default.html

❑ About Last.fm

Last.fm learns what you love... and it's a great way to discover new music.

Your new DENON Network CD receiver is very clever. You can create a free Last.fm profile when you start using your DENON Network CD receiver and magically keep track of all the songs you hear.

When you sign in at www.last.fm, you can see your top music charts, view thousands of reviews, biographies and artwork, and get recommendations for local performances you won't want to miss.

With an affordable subscription you can enjoy an endless choice of personalised ad-free radio stations. Check out www.last.fm/subscribe today for more details.

Your subscription also gives you access to Last.fm radio on a great range of music products, including your DENON Network CD Receiver. This feature is not available in all countries. Visit www.last.fm/hardware to find out more.

Explanation terms

A

AES (Advanced Encryption Standard)

This is a next generation standard encryption method replacing the current DES and 3DES, and because of its high security it is expected to be applied widely to wireless LANs in the future. It uses the "Rijndael" algorithm developed by two Belgian cryptographers to divide the data into blocks of fixed lengths and encrypt each block. It supports data lengths of 128, 192 and 256 bits and key lengths of 128, 192 and 256 bits as well, offering extremely high encryption security.

B

Bit rate

This expresses the read amount per 1 second of video/audio data recorded in a disc.

D

DLNA

DLNA and DLNA CERTIFIED are trademarks and/or service marks of Digital Living Network Alliance. Some contents may not be compatible with other DLNA CERTIFIED™ products.

F

Finalize

This is processing that enables playing back of disc of CD, which was recorded using a recorder, by other players.

I

IEEE 802.11b

This is one wireless LAN standard set by the 802 working group that establishes LAN technology standards at the IEEE (Institute of Electrical and Electronics Engineers) of the United States. It uses the 2.4 GHz band usable freely without a radio frequency license (ISM band), enabling communications at a maximum speed of 11 Mbps.

- The value indicated above is the maximum theoretical value for the wireless LAN standard, and does not indicate the actual data transfer rate.

IEEE 802.11g

This is another wireless LAN standard set by the 802 working group that establishes LAN technology standards at the IEEE (Institute of Electrical and Electronics Engineers) of the United States, and is compatible with IEEE 802.11b. It also uses the 2.4 GHz band, but enables communications at a maximum speed of 54 Mbps.

- The value indicated above is the maximum theoretical value for the wireless LAN standard, and does not indicate the actual data transfer rate.

M

MP3 (MPEG Audio Layer-3)

This is an internationally standardized audio data compression scheme, using the "MPEG-1" video compression standard. It compresses the data volume to about one eleventh its original size while maintaining sound quality equivalent to a music CD.

MPEG (Moving Picture Experts Group), MPEG-2, MPEG-4

These are the names for digital compression format standards used for the encoding of video and audio. Video standards include "MPEG-1 Video", "MPEG-2 Video", "MPEG-4 Visual", "MPEG-4 AVC". Audio standards include "MPEG-1 Audio", "MPEG-2 Audio", "MPEG-4 AAC".

N

Network Names

(SSID: Security Set Identifier)

When forming wireless LAN networks, groups are formed to prevent interference, data theft, etc. This grouping is done by "SSID" or "Security Set Identifiers". For further security, a WEP key is set and signal transfer is not possible unless the SSID and WEP key match.

P

Protection circuit

This is a function to prevent damage to components within the power supply when an abnormality such as an overload, excess voltage occurs or temperature for any reason.

In this unit, the power turns off suddenly.

S

Sampling frequency

Sampling involves taking a reading of a sound wave (analog signal) at regular intervals and expressing the height of the wave at each reading in digitized format (producing a digital signal).

The number of readings taken in one second is called the "sampling frequency". The larger the value, the closer the reproduced sound is to the original.

Speaker impedance

This is an AC resistance value, indicated in Ω (ohms). Greater power can be obtained with this value smaller.

T

TKIP (Temporal Key Integrity Protocol)

This is a network key used for WPA. The encryption algorithm is RC4, the same as for WEP, but the security level is increased by changing the network key used for encryption for each packet.

V

vTuner

This is a free online content server for Internet radio. Note that usage fees are included in upgrade costs.

For inquiries about this service, visit the vTuner site below.

vTuner website: <http://www.radiodemon.com>

This product is protected by certain intellectual property rights of Nothing Else Matters Software and BridgeCo. Use or distribution of such technology outside of this product is prohibited without a license from Nothing Else Matters Software and BridgeCo or an authorized subsidiary.

W

WEP Key (Network Key)

This is key information used for encrypting data when conducting data transfer. On this unit, the same WEP key is used for data encryption and decryption, so the same WEP key must be set on both devices in order for communications to be established between them.

Wi-Fi®

Wi-Fi Certification assures tested and proven interoperability by the Wi-Fi Alliance, a group certifying interoperability among wireless LAN devices.

Windows Media DRM

This is a copyright protection technology developed by Microsoft.

Content providers are using the digital rights management technology for Windows Media contained in this device (WM-DRM) to protect the integrity of their content (Secure Content) so that their intellectual property, including copyright, in such content is not misappropriated. This device uses WM-DRM software to play Secure Content (WM-DRM Software). If the security of the WM-DRM Software in this device has been compromised, owners of Secure Content (Secure Content Owners) may request that Microsoft revoke the WM-DRM Software's right to acquire new licenses to copy, display and/or play Secure Content. Revocation does not alter the WM-DRM Software's ability to play unprotected content.

A list of revoked WM-DRM Software is sent to your device whenever you download a license for Secure Content from the Internet or from a PC.

Microsoft may, in conjunction with such license, also download revocation list onto your device on behalf of Secure Content Owners.

Windows Media Player Ver. 11

This is a media player distributed free of charge by Microsoft Corporation.

It can be used to play playlists created with Windows Media Player Ver. 11 as well as files in such formats as WMA, DRM WMA, MP3 and WAV.

WMA (Windows Media Audio)

This is audio compression technology developed by Microsoft Corporation.

WMA data can be encoded using Windows Media® Player Ver.7, 7.1, Windows Media® Player for Windows® XP and Windows Media® Player 9 Series.

To encode WMA files, only use applications authorized by Microsoft Corporation. If you use an unauthorized application, the file may not work properly.

WPA (Wi-Fi Protected Access)

This is a security standard established by the Wi-Fi Alliance. In addition to the conventional SSID (network name) and WEP key (network key), it also uses a user identification function and encrypting protocol for stronger security.

WPA2 (Wi-Fi Protected Access 2)

This is a new version of the WPA established by the Wi-Fi Alliance, compatible with more secure AES encryption.

WPA-PSK/WPA2-PSK (Pre-shared Key)

This is a simple authentication system for mutual authentication when a preset character string matches on the wireless LAN access point and client.

WPS (Wi-Fi Protected Setup)

This is a standard drawn up by the Wi-Fi Alliance to ease the task of setting up wireless LAN connections and configuring security.

There are two methods: push-button and PIN (Personal Identification Number) code.

Troubleshooting

If a problem occurs first check the following:

1. Are the connections correct?
2. Is the set being operated as described in the owner's manual?
3. Are the other components operating properly?

If this unit does not operate properly, check the items listed in the table below. If the problem persists, there may be a malfunction.

In this case, disconnect the power immediately and contact your retail outlet.

[General]

Symptom	Cause	Countermeasure	Page
Set does not operate properly.	<ul style="list-style-type: none"> • External noise or interference is causing the set to malfunction. 	<ul style="list-style-type: none"> • Reset the microprocessor. 	35
Display not lit and sound not produced when power switched to on.	<ul style="list-style-type: none"> • Power cord not plugged in securely. 	<ul style="list-style-type: none"> • Check the connections on the set's rear panel and the connection of the power plug to the power outlet. 	10
Display lit but sound not produced.	<ul style="list-style-type: none"> • Wrong input source selected. • Volume control set to minimum. • MUTING is on. 	<ul style="list-style-type: none"> • Select the appropriate input source. • Turn volume up to suitable level. • Switch off MUTING. 	12 12 12
Display is off.	<ul style="list-style-type: none"> • The Dimmer setting is set to "OFF". 	<ul style="list-style-type: none"> • Set to something other than "OFF". 	13
Power turns off suddenly and POWER indicator flashes red. (Flashes at 0.5 second intervals)	<ul style="list-style-type: none"> • Core wires of two speakers are touching each other or a core wire is sticking out of the terminal and touching the set's rear panel, activating the protection circuit. 	<ul style="list-style-type: none"> • First unplug the power cord, then twist the core wires tightly or terminate the speaker cables, then reconnect. 	5
Power turns off suddenly and POWER indicator flashes red. (Flashes at 0.25 second intervals)	<ul style="list-style-type: none"> • Set is damaged. 	<ul style="list-style-type: none"> • Turn off the power and contact a DENON service center. 	–
Power turns off suddenly and POWER indicator flashes red. (Flashes at 2 second intervals)	<ul style="list-style-type: none"> • Protection circuit activated due to a rise in internal temperature. 	<ul style="list-style-type: none"> • Turn off the power, wait for the set to fully cool down, then turn the power back on. • Place the set in a well-ventilated location. 	6 IV

The TV sound is not output.	<ul style="list-style-type: none"> • Other digital audio signals than 2 channel linear PCM cannot be input through AUX IN 3 (OPTICAL) terminal of this unit. 	<ul style="list-style-type: none"> • When you try to input digital audio signals other than 2 channel linear PCM to this unit, set the digital audio output setting of the TV to 2 channel PCM. For details, see the operating instructions of the TV. 	-
"No Network Connection" is displayed.	The network is not properly set up.	<ul style="list-style-type: none"> • Perform "Network First Setup." • Select a source other than the network function. 	25 12

[Remote control]

Symptom	Cause	Countermeasure	Page
Set does not work properly when remote control operated.	• Batteries are worn.	• Replace with new batteries.	4
	• You are operating outside of the specified range.	• Operate within the specified range.	4
	• Obstacle between main unit and remote control.	• Remove the obstacle.	-
	• The batteries are not inserted in the proper direction, as indicated by the polarity marks in the battery compartment.	• Insert the batteries in the proper direction, following the polarity marks in the battery compartment.	4
	• The set's remote control sensor is exposed to strong light (direct sunlight, fluorescent light, etc.).	• Move the set to a place in which the remote control sensor will not be exposed to strong light.	4

[CD]

Symptom	Cause	Countermeasure	Page
"Unsupported" is shown on the display even though a CD is loaded.	• The disc is not properly loaded.	• Reload the disc.	3
Disc does not play when ►/II button is pressed.	• The disc is dirty or scratched.	• Wipe the disc clean or replace the disc.	3
A specific part of a disc is not played.	• The disc is dirty or scratched.	• Wipe the disc clean or replace the disc.	3
A CD-R or CD-RW disc cannot be played.	<ul style="list-style-type: none"> • The disc has not been finalized. • The recording conditions are bad or the quality of the disc itself is poor. 	<ul style="list-style-type: none"> • Finalize the disc then play it. • Use a properly recorded disc. 	3 -
MP3 and WMA files cannot be played.	• The file formats, extensions or settings made when the disc was created are not compatible with this unit.	• Create discs with file formats, extensions or settings compatible with this unit.	41

[Tuner]

Symptom	Cause	Countermeasure	Page
Continuous noise is heard when receiving FM programs.	• Antenna cable is not properly connected.	<ul style="list-style-type: none"> • Connect the antenna cable properly. • Connect an outdoor antenna. 	7 -
Hissing or continuous noise is heard when receiving AM programs.	• This may be noise from a TV or interference from a broadcast station.	<ul style="list-style-type: none"> • Turn off the TV. • Change the position and direction of the AM loop antenna. 	- 7

[Internet radio/Music server/iPod/USB memory device]

Symptom	Cause	Countermeasure	Page
When a USB memory device is connected, "USB" is not displayed.	<ul style="list-style-type: none"> The set cannot recognize a USB memory device. A USB memory device not conforming to mass storage class or MTP standards is connected. A USB memory device that the set cannot recognize is connected. USB memory device is connected via USB hub. 	<ul style="list-style-type: none"> Check the connection. 	9
		<ul style="list-style-type: none"> Connect a USB memory device conforming to mass storage class or MTP standards. 	-
		<ul style="list-style-type: none"> This is not a malfunction. DENON does not guarantee that all USB memory devices will operate or receive power. 	-
		<ul style="list-style-type: none"> Connect the USB memory device directly to the USB port. 	-
iPod cannot be played.	<ul style="list-style-type: none"> Input source other than "iPod" or "USB" is selected. Cable is not properly connected. 	<ul style="list-style-type: none"> Switch the INPUT to "iPod" or "USB". 	17
		<ul style="list-style-type: none"> Reconnect. 	9
Files on a USB memory device cannot be played.	<ul style="list-style-type: none"> USB memory device is in a format other than FAT16 or FAT32. USB memory device is divided into multiple partitions. Files are stored in a non-compatible format. You are attempting to play a file that is copyright protected. 	<ul style="list-style-type: none"> Set the format to FAT16 or FAT32. For details, refer to the USB memory device's operating instructions. 	-
		<ul style="list-style-type: none"> When divided into multiple partitions, only files stored in the top partition can be played. 	-
		<ul style="list-style-type: none"> Record the files in a compatible format. 	42
		<ul style="list-style-type: none"> Files that are copyright protected cannot be played on this set. 	42
Internet radio cannot be played.	<ul style="list-style-type: none"> Ethernet cable is not properly connected or network is disconnected. Program is being broadcast in non-compatible format. The computer's or router's firewall is activated. Radio station is not currently broadcasting. IP address is wrong. 	<ul style="list-style-type: none"> Check the connection status. 	8
		<ul style="list-style-type: none"> Only Internet radio programs in MP3 and WMA can be played on this set. 	43
		<ul style="list-style-type: none"> Check the computer's or router's firewall settings. 	-
		<ul style="list-style-type: none"> Choose a radio station that is currently broadcasting. 	19
		<ul style="list-style-type: none"> Check the set's IP address. 	25
Files stored on a computer cannot be played.	<ul style="list-style-type: none"> Files are stored in a non-compatible format. You are attempting to play a file that is copyright protected. Set and computer are connected by USB cable. 	<ul style="list-style-type: none"> Record in a compatible format. 	43
		<ul style="list-style-type: none"> Files that are copyright protected cannot be played on this set. 	43
		<ul style="list-style-type: none"> The set's USB port cannot be used for connection to a computer. 	-

Symptom	Cause	Countermeasure	Page
Server is not found, or it is not possible to connect to the server.	<ul style="list-style-type: none"> The computer's or router's firewall is activated. Computer's power is not turned on. Server is not running. Set's IP address is wrong. 	<ul style="list-style-type: none"> Check the computer's or router's firewall settings. Turn on the power. 	-
		<ul style="list-style-type: none"> Launch the server. Check the set's IP address. 	-
		<ul style="list-style-type: none"> Check the set's IP address. 	25
Cannot connect to preset or favorite radio stations.	<ul style="list-style-type: none"> Radio station is not currently broadcasting. Radio station is not currently in service. 	<ul style="list-style-type: none"> Wait a while before trying again. It is not possible to connect to radio stations that are no longer in service. 	-
For some radio stations, "Server Full" or "Connection Down" is displayed and station cannot be connected to.	<ul style="list-style-type: none"> Station is congested or not currently broadcasting. 	<ul style="list-style-type: none"> Wait a while before trying again. 	-
Sound is broken during playback.	<ul style="list-style-type: none"> Network's signal transfer speed is slow or communications lines or radio station is congested. 	<ul style="list-style-type: none"> This is not a malfunction. When playing broadcast data with a high bit rate, the sound may be broken, depending on the communications conditions. 	-
Sound quality is poor or played sound is noisy.	<ul style="list-style-type: none"> File being played has a low bit rate. 	<ul style="list-style-type: none"> This is not a malfunction. 	-

[Last.fm]

Symptom	Cause	Countermeasure	Page
Cannot login to Last.fm. ("Subscription required" is displayed.)	<ul style="list-style-type: none"> Login authentication error. If a nonsubscriber user accesses it. Or when the listening limitation exceeds it. 	<ul style="list-style-type: none"> Enter the correct username and password and retry login. You need to be a paid Last.fm subscriber to listen to this. Visit www.last.fm/subscribe to upgrade. 	–
Cannot play back music. ("Library empty" is displayed.)	<ul style="list-style-type: none"> No music data to be played back. 	<ul style="list-style-type: none"> Visit www.last.fm/download and install the Scrobbler to add the music you've played to your profile and make this feature work. 	–
Cannot play back music. ("No more tracks" is displayed.)	<ul style="list-style-type: none"> When you played all tunes of the playlist. 	<ul style="list-style-type: none"> Select another playlist. 	–
Cannot access the Last.fm. ("No network Connection" is displayed.)	<ul style="list-style-type: none"> Cannot connect to the network. 	<ul style="list-style-type: none"> Check the network environment. 	8
Cannot access the Last.fm. ("Not available in your country" is displayed.)	<ul style="list-style-type: none"> You are accessing the network from a country where Last.fm radio is not available. 	<ul style="list-style-type: none"> Last.fm radio is not available in all countries. Please check www.last.fm/hardware for more information. 	–
Cannot login to Last.fm. ("Incorrect user or password" is displayed.)	<ul style="list-style-type: none"> Incorrect username or password entered for login authentication. 	<ul style="list-style-type: none"> Enter the correct username and password and retry login. 	–
Cannot create and register an account. ("Try another username" is displayed.)	<ul style="list-style-type: none"> The username has already been taken. 	<ul style="list-style-type: none"> Enter another username to create and register the account. 	–

[Napster]

Symptom	Cause	Countermeasure	Page
Cannot login to Napster. ("Subscription required" is displayed.)	<ul style="list-style-type: none"> Login authentication error. If a nonsubscriber user accesses it. Or when the listening limitation exceeds it. 	<ul style="list-style-type: none"> Enter the correct username and password and retry login. 	–
Cannot login to Napster. ("Incorrect Username or Password" is displayed.)	<ul style="list-style-type: none"> Incorrect username or password entered for login authentication. 	<ul style="list-style-type: none"> Enter the correct username and password and retry login. Check if the Username for Napster has been properly entered. Re-enter the Password. (Password is not displayed.) http://www.napster.com/choose/index_default.html 	–

[Wireless LAN]

Symptom	Cause	Countermeasure	Page
Cannot connect to network.	<ul style="list-style-type: none"> The settings of the SSID and network key (WEP) are incorrect. The reception is poor and the signals cannot be received. 	<ul style="list-style-type: none"> Match the network settings with this unit settings. Shorten the distance from the wireless LAN's access point, remove any obstacles and otherwise improve visibility, then try reconnecting. Also install away from microwave ovens and the access points of other networks. 	29, 30
	<ul style="list-style-type: none"> There are multiple networks and the usable channels overlap. 	<ul style="list-style-type: none"> Set the access point's channel settings away from the channels used for other networks. Alternatively, connect using a network cable. 	–
	<ul style="list-style-type: none"> The router power is off. 	<ul style="list-style-type: none"> Turn on the router power. 	–
Played sound is interrupted or sound cannot be played.	<ul style="list-style-type: none"> There are multiple networks and the usable channels overlap. 	<ul style="list-style-type: none"> Set the access point's channel settings away from the channels used for other networks. Alternatively, connect using a network cable. 	–

Specifications

❑ CD player

• Audio performance	
S/N ratio (1 kHz)	100 dB
Dynamic range (1 kHz)	100 dB
Total harmonic distortion (1 kHz)	0.01 %

❑ Audio AMP

Rated output:	2-channel driving 65 W + 65 W (4 Ω/ohms, 1 kHz, T.H.D. 0.7 %) 80 W + 80 W (4 Ω/ohms)
Dynamic power:	80 W + 80 W (4 Ω/ohms)
High frequency distortion:	0.1 % (Rated output: -3 dB), 4 Ω/ohms, 1 kHz
Input sensitivity/impedance	
AUX1, AUX2	200 mV/32 kΩ
Portable in	110 mV/24 kΩ
Frequency response (5 W, 8 Ω)	
AUX input	5 Hz to 20 kHz (±3 dB)
Total harmonic distortion (1 kHz, 5 W, 8 Ω)	
AUX input	0.05 %
S/N ratio (10 W, 8 Ω, IHF-A)	
AUX input	86 dB

❑ Tuner

• FM tuner	
Range of receivable frequencies	87.5 to 108.0 MHz
S/N ratio (mono)	65 dB
Sensitivity (S/N 30 dB)	9 dBμV (IHF)
• AM tuner	
Range of receivable frequencies	522 to 1611 kHz
S/N ratio	40 dB
Sensitivity (S/N 20 dB)	55 dBμV/m

❑ Clock

Clock method	Within 1 – 2 minutes per month
--------------	--------------------------------

❑ Wireless LAN

Network type (wireless LAN standards)	Conforming to IEEE 802.11b Conforming to IEEE 802.11g (Conforming to Wi-Fi®)*
Transfer rate	DS-SS: 11 / 5.5 / 2 / 1 Mbps (Automatic switching) OFDM: 54 / 48 / 36 / 24 / 18 / 12 / 9 / 6 Mbps (Automatic switching)
Security	SSID (Network name) WEP key (network key) (64/128 bits) WPA-PSK (TKIP/AES) WPA2-PSK (TKIP/AES)
Used frequency range	2,412 MHz – 2,472 MHz
No. of channels	Conforming to IEEE 802.11b : 13ch (DS-SS) (Of which 1 channel used) Conforming to IEEE 802.11g : 13ch (OFDM) (Of which 1 channel used)
❑ Power supply	
Power supply voltage/frequency	AC 230 V, 50 Hz
Power consumption	65 W
Power consumption in standby mode	0.4 W
❑ Miscellaneous	
External dimensions	280 (W) x 112 (H) x 299 (D) mm
Weight	4.3 kg

- * Wi-Fi® conformity indicates tested and proven interoperability by the “Wi-Fi Alliance”, a group certifying interoperability among wireless LAN devices.
- For purposes of improvement, specifications and design are subject to change without notice.

Index

A

Accessories	2
AES	30, 44
AM loop antenna	7
Auto preset	16
Auto Standby	33

B

BASS	12
Bit rate	41, 42, 43, 44
Browse mode	17

C

Cable	
Audio cable	5, 6, 9, 10
Ethernet cable	8
Optical cable	6
Pin-plug cable	5
Speaker cable	5
Stereo pin-plug cable	6
Characters	29, 30, 34, 35
Connection	
Antenna	7
iPod	9
Network	8
Portable audio player	10
Power cord	10
Recording components	6
Speaker	5
TV	6
USB memory device	9
Current time	11, 27

D

Display's brightness	13
DLNA	44

F

Favorite list	23
Finalize	3, 44
Firmware update	33
FM indoor antenna	7
Friendly Name Edit	32
Front panel	36

H

Headphones	13
------------	----

I

IEEE 802.11b	44
IEEE 802.11g	44
Input source	12
Inputting characters	34
Internet radio	19

L

Last.fm	21
Last.fm Display	30

M

Menu map	25
MP3	15, 42, 43, 44
MPEG	44
MPEG-4 AAC	42
Music server	20
Mute	12

N

Napster	22
Network Names (SSID)	44
Network Standby	32

P

Party mode	31
PC Language	32
Playback	
AUX	23
CD	13
Files	15
FM/AM broadcasts	16
Internet radio	19
iPod	17
Napster	22
Network audio	19, 43
Portable audio player	23
Program	14
Random	14
Repeat	14
USB memory device	18, 42
Protection circuit	6, 44
PTY	24

R

RDS	24
Rear panel	37
Remote control	4, 38, 39, 40
Batteries	4
Remote mode	17
Resetting the microprocessor	35
RT	25

S

Sampling frequency	41, 42, 43, 44
Screen saver	33
SDB	12
Setting	
Clock	27
Network	28, 29, 30
Other	33
Timer	26
Sleep timer	13
Speaker impedance	5, 44
Speaker optimize	33
Subwoofer	5

T

Timer	26
TKIP	44
Tone	12
Top panel	37
TP	25
TREBLE	12

V

Volume	12
vTuner	43, 44

W

WEP Key	30, 44
Wi-Fi	44
Windows Media DRM	43, 44
Windows Media Player Ver. 11	20, 44
WMA	15, 42, 43, 44
WPA	30, 45
WPA2	30, 45
WPA-PSK/WPA2-PSK	30, 45
WPS	30, 45



DENON

www.denon.com

D&M Holdings Inc.
Printed in China 5411 10540 005D